

# **INSTRUCTION MANUAL**

VIBRATION METER

**VM-82**

[www.64817.com](http://www.64817.com)

 **RION CO., LTD.**

3-20-41 Higashimotomachi, Kokubunji, Tokyo 185-8533, Japan

[www.64817.com](http://www.64817.com)



## Organization of This Manual

This manual describes the features and operation of the General-Purpose Vibration Meter VM-82. If the unit is used together with other equipment to configure a measurement system, be sure to carefully read the documentation of all other components as well. Also, the following pages contain important information with regard to safety. Be sure to read and observe all precautions.

The manual contains the following sections.

### **Outline**

Gives basic information on the configuration and features of the unit, and contains a block diagram.

### **Controls and Features**

Briefly identifies and explains all parts of the unit.

### **Display Explanation**

Explains the LCD display located on the front panel of the unit.

### **Preparations**

Describes how to insert batteries, connect cables, and mount the accelerometer.

### **Setup**

Describes how to set the time and the sensitivity.

### **Measurement**

Describes the basic steps for measurement.

### **Serial Interface**

Describes how to use the serial interface for connection to a computer.

### **Reference**

Provides information about filter frequency response characteristics, as well as an input connector wiring diagram.

## Use of Optional Accessories

Explains how to connect the optional AC adapter and printer, and how to connect the unit to a computer.

## Specifications

Lists the technical specifications of the unit.

- \* All company names and product names mentioned in this manual are usually trademarks or registered trademarks of their respective owners.



The product described in this manual is in conformity with the following European standards;

EN 61000-6-3:2001

EN 61000-6-1:2001

Note: In case one or more cables (AC output cable, DC output cable, AC adapter cable or Interface cable) are connected to the instrument, the measurement result may be influenced when the instrument is used in a radio-frequency electromagnetic (RFE) field.

To conform to the EU requirement of the Directive 2002/96/EC on Waste Electrical and Electronic Equipment, the symbol mark on the right is shown on the instrument.



# FOR SAFETY

In this manual, important safety instructions are specially marked as shown below. To prevent the risk of death or injury to persons and severe damage to the unit or peripheral equipment, make sure that all instructions are fully understood and observed.

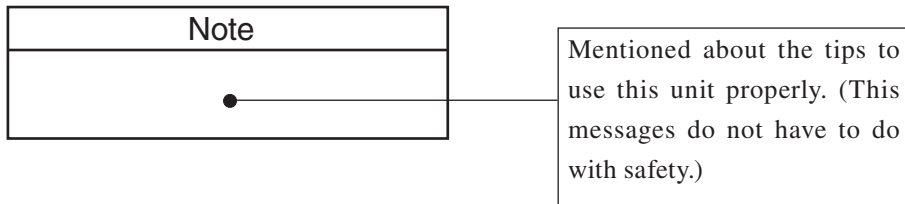
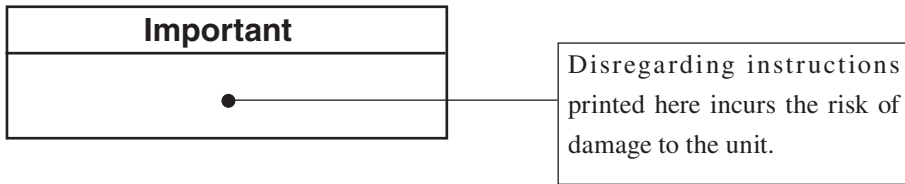
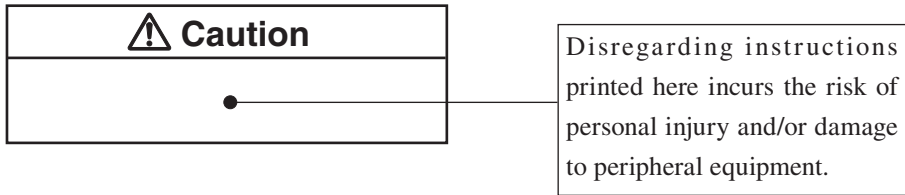

# Precautions

- Operate the unit only as described in this manual.
- Take care not to drop the unit, and protect it from shocks and vibrations.
- Do not store or use the unit in locations where the unit may be subject to
  - splashes of water or high levels of dust,
  - air with high salt or sulphur content, or other gases or chemicals,
  - high temperature (50°C), high humidity (90%RH), or direct sunlight,
  - directly transmitted vibrations or shock.
- Observe the following precautions after using the unit:
  - Always switch off the power.
  - When the unit is not to be used for a week or longer, remove the batteries to prevent possible damage caused by battery leakage.
- Do not disassemble the unit or attempt internal alterations.
- Have the unit and the accelerometer checked and serviced about once every 18 to 24 months. (Sensitivity calibration can be performed at the factory for a fee.)
- When powering the unit externally, use only the specified optional AC adapter (NC-34 or NC-98 series). Using a different adapter may cause malfunction or damage.
- Do not tap the LCD panel for example with your finger or a pen, to prevent possible malfunction or damage.
- In case of malfunction, do not attempt any repairs. Note the condition of the unit clearly and contact the supplier.
- When disposing of the unit or the accessories, follow national and local regulations regarding waste disposal.

- In previous versions of this product, the two vibration acceleration units  $m/s^2$  and G were used. However, G is not an SI unit, and the product has been changed to employ only SI units. The instruction manual therefore has been revised as follows.
  - All occurrences of G (G, mV/G, pc/G, etc.) → deleted
  - All occurrences of ACC1 (ACC1, ACC1(G), etc.) → deleted
  - ACC2 → changed to ACC

# Contents

Organization of This Manual .....	i
FOR SAFETY.....	iii
Outline.....	1
Controls and Features.....	3
Front panel .....	3
Front panel (setting panel cover open) .....	5
Right side panel .....	7
Left side panel .....	9
Rear.....	10
Accelerometer.....	11
Display Explanation .....	12
Preparations .....	14
Backup (lithium) battery replacement.....	14
Main power supply .....	16
Accelerometer connection.....	18
Accelerometer mounting.....	20
Power-up and version indication/unit initialization .....	24
Setup.....	26
Setting mode.....	26
Measurement.....	28
Vibration measurement .....	28
Storing measurement data.....	31
Recall mode.....	33
Clearing stored data .....	34
Output signal recording .....	35
About the AC OUT signal .....	36
About the DC OUT signal .....	37
Serial Interface.....	38
Interface parameters .....	38
Transfer Procedure .....	39



Error Processing .....	42
Command format.....	43
Command list .....	44
Command description.....	45
Reference .....	50
High-pass filter characteristics .....	50
Low-pass filter characteristics.....	51
Input connector wiring diagram .....	52
Use of Optional Accessories.....	53
Use of AC adapter (option) .....	53
Connection to a printer .....	54
Connection to a computer .....	58
Specifications .....	59



# Outline

The VM-82 is designed mainly for routine maintenance and monitoring of rotational and other industrial machinery. It can measure acceleration (ACC), velocity (VEL), and displacement (DISP) using a suitable frequency range to evaluate machine vibrations.

Besides a large numeric readout, a bar graph display that functions like an analog meter makes it easy to observe any changes in measurement value.

The internal memory allows storage of measurement data, for example for later processing on a computer.

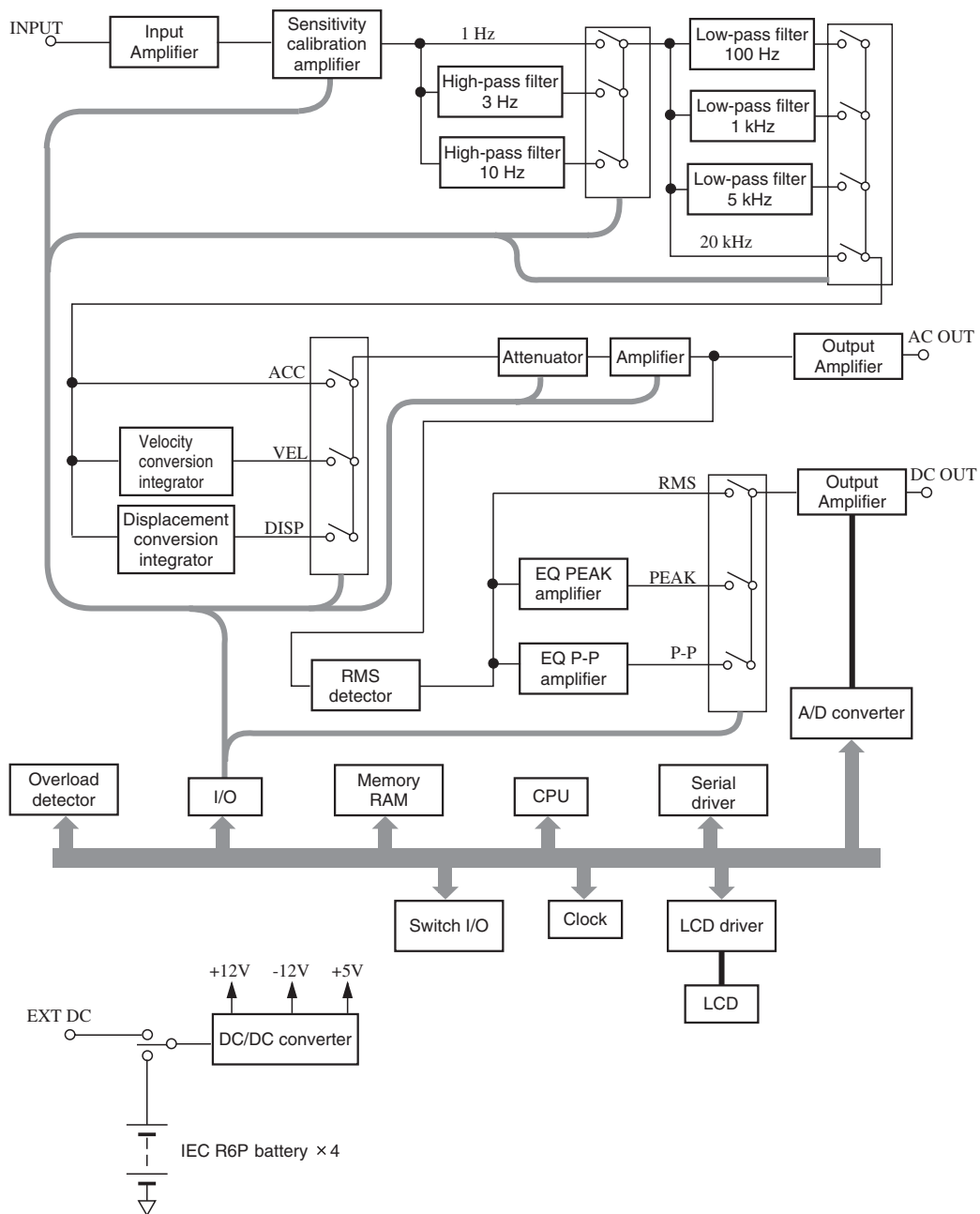

VM-82 block diagram

# Controls and Features

## Front panel

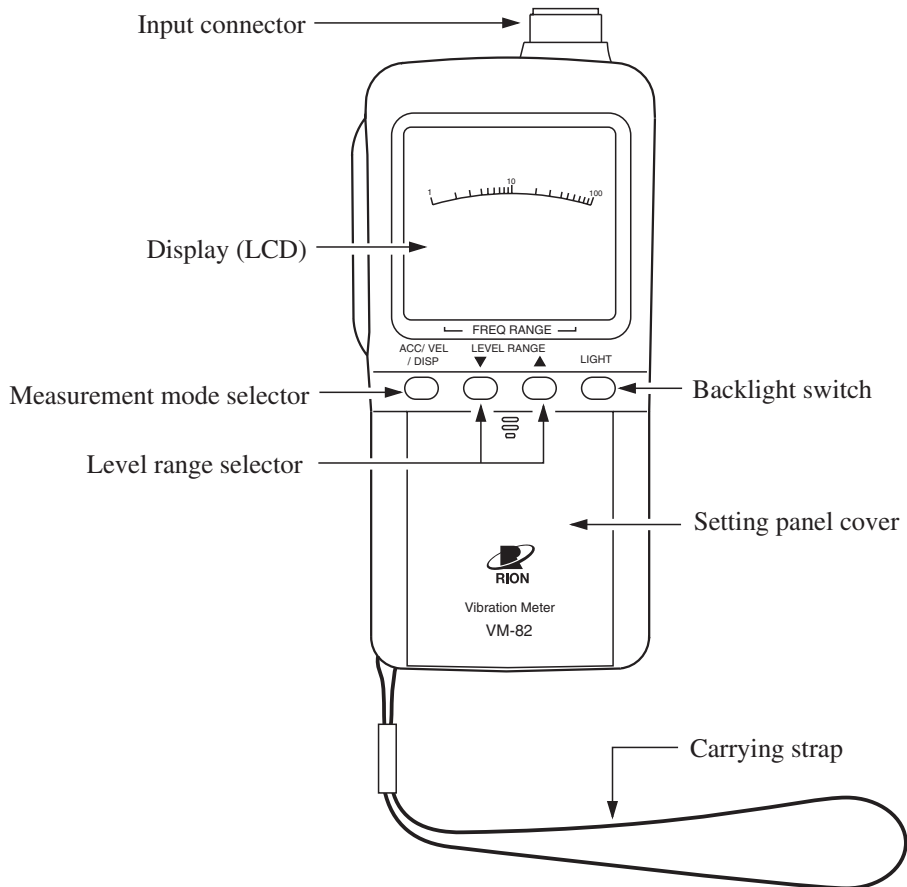

### Input connector

The accelerometer PV-57A is to be connected here, using the supplied accelerometer cable. When the preamplifier VP-26C is used, connect it directly or via the extension cable EC-04.

### Display

Shows the measurement value and status information (see page 12).

## Measurement mode selector (ACC/VEL/DISP)

This button serves to select measurement of acceleration (ACC), velocity (VEL), or displacement (DISP). With each push of the button, the selection changes in the order ACC ( $\text{m/s}^2$ )  $\rightarrow$  VEL (mm/s)  $\rightarrow$  DISP (mm)  $\rightarrow$  ACC ( $\text{m/s}^2$ ) etc.

## Level range selector (LEVEL, RANGE, ▼, ▲)

These buttons serve to set the level range. Pressing the ▲ button switches to the next higher range and pressing the ▼ button to the next lower range.

The available ranges for the various modes are as listed below.

Using the supplied accelerometer PV-57A or another accelerometer with a sensitivity of 1.0 to 9.9  $\text{mV}/(\text{m/s}^2)$  (1.0 to 9.9  $\text{pC}/(\text{m/s}^2)$ )

ACC: 1, 10, 100, 1000  $\text{m/s}^2$

VEL: 10, 100, 1000 mm/s

DISP: 0.1, 1, 10, 100 mm

When using an accelerometer with a sensitivity of 0.1 to 0.99  $\text{mV}/(\text{m/s}^2)$  (0.1 to 0.99  $\text{pC}/(\text{m/s}^2)$ ), the above ranges are to be multiplied by a factor of 10.

When using an accelerometer with a sensitivity of 10 to 99  $\text{mV}/(\text{m/s}^2)$  (10 to 99  $\text{pC}/(\text{m/s}^2)$ ), the above ranges are to be multiplied by a factor of 1/10.

## Backlight switch (LIGHT)

Toggles the display backlighting on an off. If the button is not pressed, the backlight will go off automatically after about 30 seconds.

## Setting panel cover

Controls for setting the frequency range, display characteristics, recall mode, and other measurement parameters are located under this cover.

Push the cover down to open it.

## Carrying strap

When holding the unit in your hand, pass this strap around your wrist to guard against dropping it.

## Front panel (setting panel cover open)

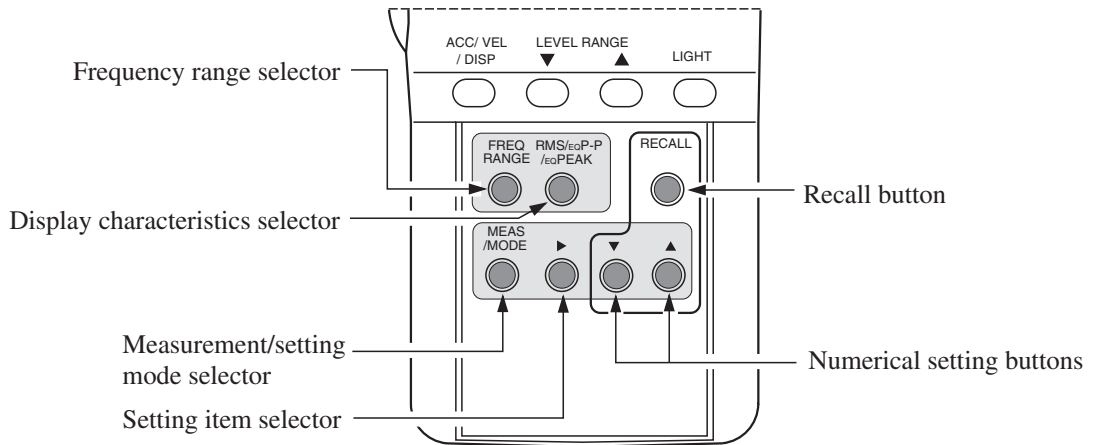

To open, slide the cover downwards while pressing on the top section.

### Frequency range selector (FREQ RANGE)

This button serves to select the frequency range for each measurement mode. Once the setting is made, that setting will be used every time the measurement mode is selected. The following settings are available (shaded settings are the factory defaults).

- ACC: **3 Hz to 1 kHz**, 3 Hz to 5 kHz, 1 Hz to 100 Hz, 3 Hz to 20 kHz
- VEL: **10 Hz to 1 kHz**, 3 Hz to 1 kHz
- DISP: **10 Hz to 500 Hz**, 3 Hz to 500 Hz

### Recall button (RECALL)

This button serves to recall stored measurement data. Press the button once to activate the recall mode (indication RECALL is shown on the display). Pressing the button again switches back to measurement mode.

### Numerical setting buttons (▼, ▲)

- Recall mode: The buttons serve to select the data address.
- Time setting: The buttons serve to set the time.
- Accelerometer sensitivity: The buttons serve to set the sensitivity value.
- Measurement mode: The buttons serve to select the data address.

## Setting item selector (▶▶)

During the setup procedure for time etc., this button serves to move among the available items. While a setting item is flashing, pushing the button cycles through the items as follows.

→Year (2009) → Month and day (01-15) → Time (12:34) → Sensitivity (5.1) →

Figures shown in brackets are examples.

In measurement mode, the button cycles through the following display settings.

→ Time (12:56) → Year (2009) → Month and day (01-17) →

Figures shown in brackets are examples.

## Measurement/setting mode selector (MEAS/MODE)

Pressing the button once in the measurement mode activates the time setting and accelerometer sensitivity setting mode. Pressing the button again switches back to the measurement screen.

## Display characteristics selector (RMS/EQ PEAK/EQ P-P)

This button serves to set the display characteristics for each measurement mode. Once the setting is made, it will be used every time the measurement mode is selected. The following settings are available (shaded settings are the factory defaults).

ACC: **EQ PEAK**, RMS  
VEL: **RMS**, EQ PEAK  
DISP: **EQ PEAK**, EQ P-P, RMS



## Right side panel

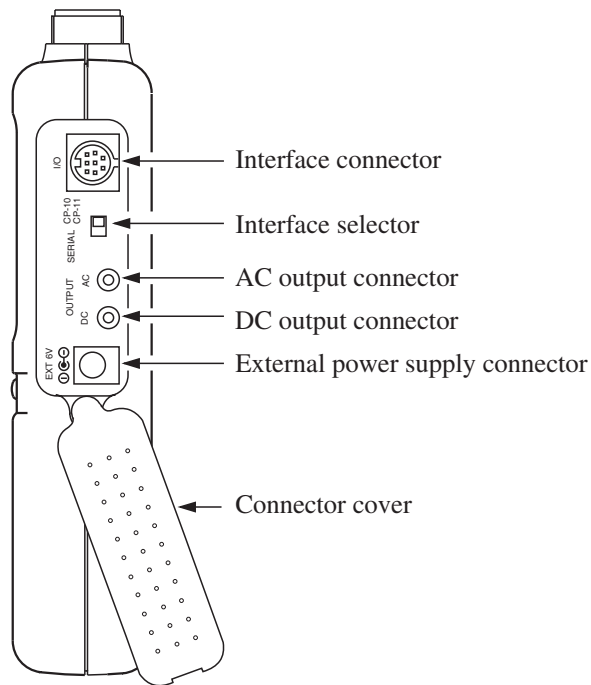

### Interface connector (I/O) (for serial communication)

Serves for connecting the VM-82 to a printer (DPU-414 or CP-10/CP-11), using the CC-87 cable. Alternatively, the CC-87E cable can be used here to connect the VM-82 to a computer.

### Interface selector (SERIAL, CP-10/CP-11)

Selects whether a printer or a computer is to be connected to the interface connector.

### AC output connector (OUTPUT AC)

An AC signal corresponding to the measurement value is output here (full-scale value 1 V).

### DC output connector (OUTPUT DC)

A DC signal corresponding to the measurement value is output here (full-scale value 1 V).

## External power supply connector (EXT 6V)

The optional AC adapter NC-34 or NC-98 series can be connected here to power the unit.

<b>Important</b>
Use only the specified AC adapter. Using a different adapter may cause malfunction or damage.

## Connector cover

To access the connectors and controls on the right side of the unit, this rubber cover can be opened by rotating it as shown in the illustration.

## Left side panel

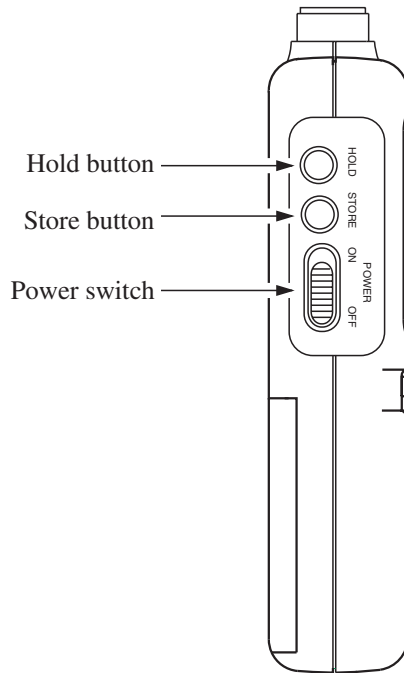

### Hold button (HOLD)

Pressing this button freezes the display with the current data. Pressing the button again cancels the hold mode.

### Store button (STORE)

Serves to store the currently displayed data in memory.

### Power switch (POWER ON/OFF)

Serves to turn the unit on and off. Do not forget to turn the unit off after use.

## Rear

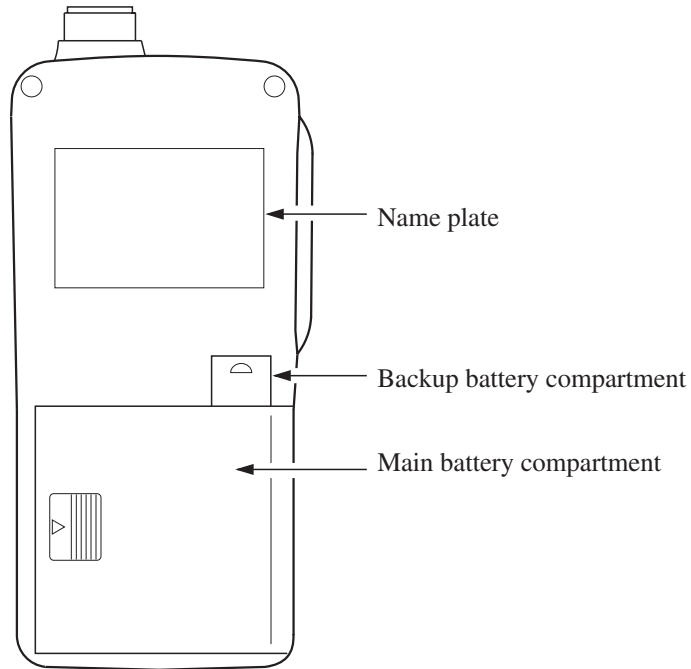

### Name plate

Shows information about the model name, type, serial number etc.

### Backup battery compartment

Contains a lithium battery (CR1/3N) that serves for internal clock backup.

### Main battery compartment

Contains four IEC R6P (size AA) batteries.

## Accelerometer

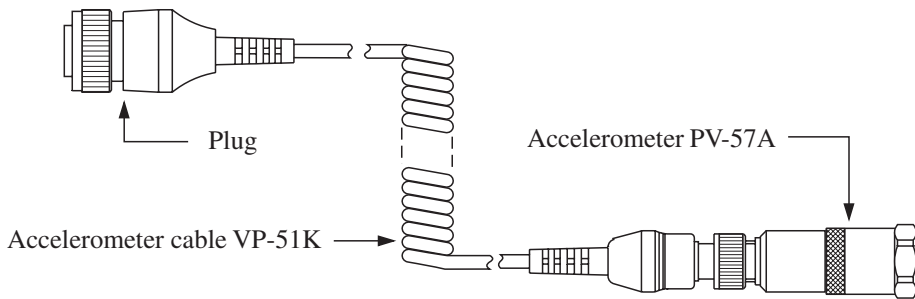

### Plug

Insert this plug into the input connector on the VM-82.

### Accelerometer PV-57A

Detects vibrations and converts them into an electrical signal. The accelerometer must be coupled to the measurement object using screw mounting or another method (see pages 20 to 23).

# Display Explanation

For explanation purposes, the illustration below shows all display elements. In actual use, not all elements will be seen together.

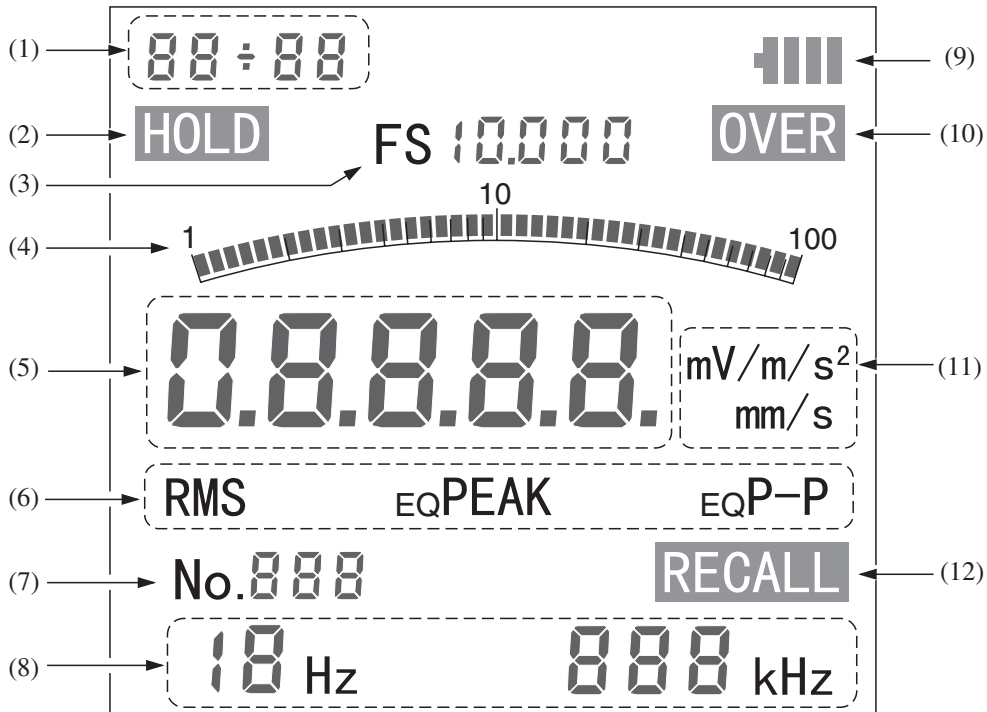

## (1) Date/time

Shows the year, month/day, or clock time.

Display example Year: 20 09  
 Month/day: 01-15  
 Time: 12:34

## (2) HOLD

When the hold button was pressed, this indication appears.

## (3) Full-scale value

Shows the full-scale value of the current range. The maximum value is 10000.

## (4) Bar graph display

This graphic display uses logarithmic compression, to achieve an effective range of 40 dB (1 to 100).

**(5) Measurement value**

Numeric indication of measurement value. Display resolution is 001 to 128, and maximum value is 12800.

**(6) Display characteristics**

Effective value:	RMS
Equivalent peak value:	EQ PEAK
Equivalent peak-to-peak value:	EQ P-P

**(7) Store data address**

Display range:	No. 000 to 999
----------------	----------------

**(8) Frequency range**

Left (lower limit)	Right (upper limit)
1 Hz	100 Hz
3 Hz	500 Hz
10 Hz	1 kHz
	5 kHz
	20 kHz

**(9) Battery status indicator**

Four-segment indicator shows the remaining battery capacity. When the indication starts to flash, correct measurement is no longer possible. Replace the batteries as described on page 17.

**(10) OVER indicator**

When overload has occurred during measurement, this indicator lights up.

**(11) Unit for numeric readout**

Acceleration (ACC):	m/s <sup>2</sup>
Velocity (VEL):	mm/s
Displacement (DISP):	mm
Accelerometer sensitivity:	mV/(m/s <sup>2</sup> )

**(12) RECALL indicator**

When the recall mode is being used, this indicator lights up.

# Preparations

This section describes the steps that must be completed before starting a measurement. Always set the power switch to OFF before inserting batteries and making any connections.

## Backup (lithium) battery replacement

The backup battery (lithium battery CR-1/3N) serves to keep the internal clock running while power to the unit is turned off. The battery is mounted in the backup battery compartment at the factory before shipping.

The life of the backup battery is approximately two years. To be on the safe side, you should replace the battery every 12 to 18 months.

### Note

With VM-82 unit versions prior to 3.0, the backup battery also serves to maintain data stored in memory.

(Replacement procedure)

1. Remove the main battery compartment cover on the rear of the unit.
2. Remove the four main batteries (IEC R6P).
3. Remove the backup battery compartment cover.

1. Lightly press the main battery compartment cover in the arrow  $\triangleright$  direction and slide the cover off.

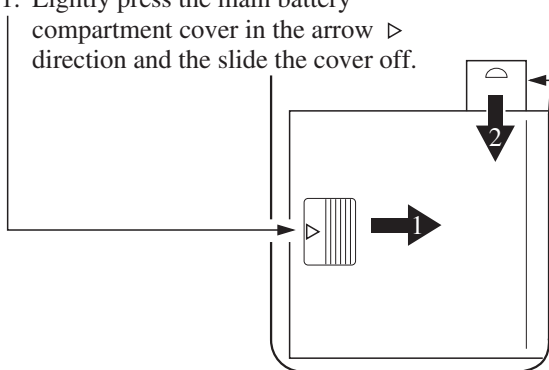

2. After removing the main battery compartment cover, slide the backup battery compartment cover in the arrow direction to remove it.



4. Insert a miniature screwdriver (1.2 to 1.5 mm) into the slit and push the lithium battery up to remove it. Since the battery will jump out if not restrained, stabilize it with your finger.

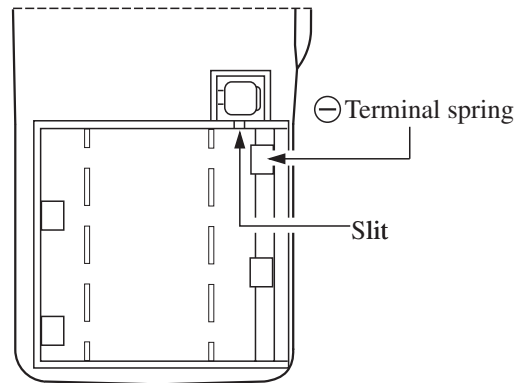

### **⚠ Caution**

Do not perform this operation while holding the unit very close to your face, since the battery may jump out suddenly.

5. Insert a new lithium battery with correct polarity. If the battery is tilted or not seated properly, push it in with the rear of a ball pen or a similar object.

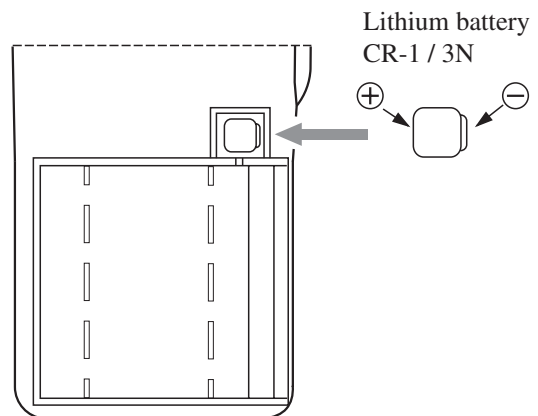

6. Replace the cover of the backup battery compartment.
7. Insert the main batteries (IEC R6P) with correct polarity. Replace the cover of the main battery compartment.

### **Important**

Perform the backup battery replacement within one minute. With VM-82 unit versions prior to 3.0, the backup battery also serves to maintain data stored in memory. If the battery is removed for a longer period, data stored in memory may be lost.

## Main power supply

This unit can be powered by four IEC R6P (size AA) batteries or by the optional AC adapter NC-34 or NC-98 series.

NC-34: For 100 V AC only

NC-98 series: For 100 to 240 V AC

### Inserting the batteries

Insert four IEC R6P (size AA) batteries with correct polarity, as shown in the illustration below.

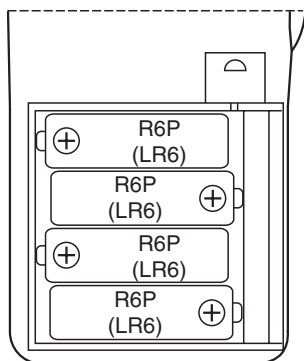

The life of the batteries depends on various usage factors. For reference, some general figures are given below.

Room temperature, backlight off, communication off, continuous use

Alkaline batteries: approx. 30 hours

Manganese batteries: approx. 14 hours

When backlight is on, power consumption increases by a factor of about 1.5.

When communication cable is connected, power consumption increases by a factor of about 1.2.

#### Important

Take care not to insert the batteries with wrong polarity. Make sure that all four batteries are of the same type. Do not mix different battery types or old and new batteries. Remove the batteries from the unit if it is not to be used for a week or more.

The battery indicator in the top right corner of the display shows the remaining battery capacity.

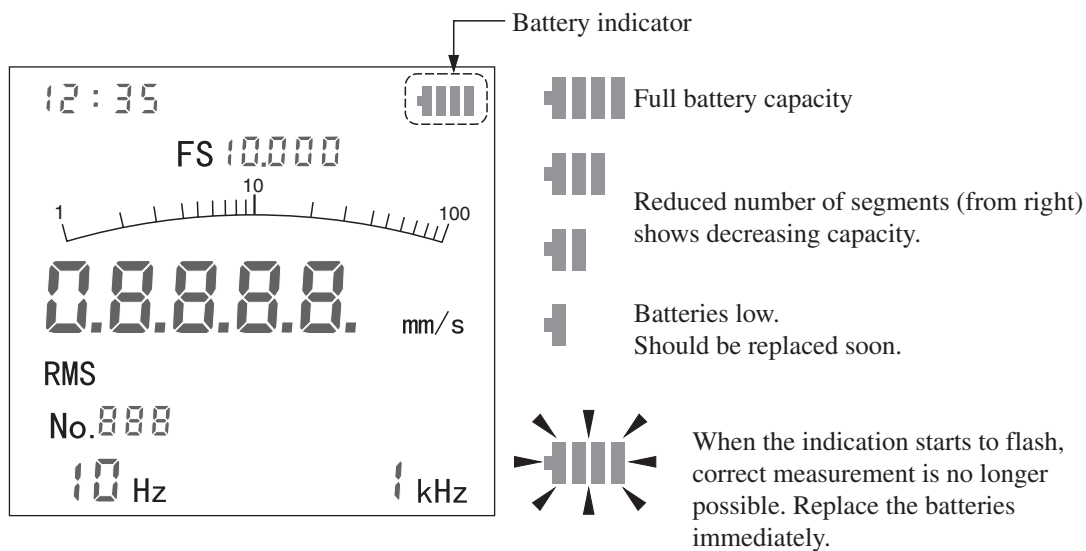

## Accelerometer connection

### When using the supplied accelerometer PV-57A

Make the connection with the supplied accelerometer cable VP-51K, as shown in the illustration below.

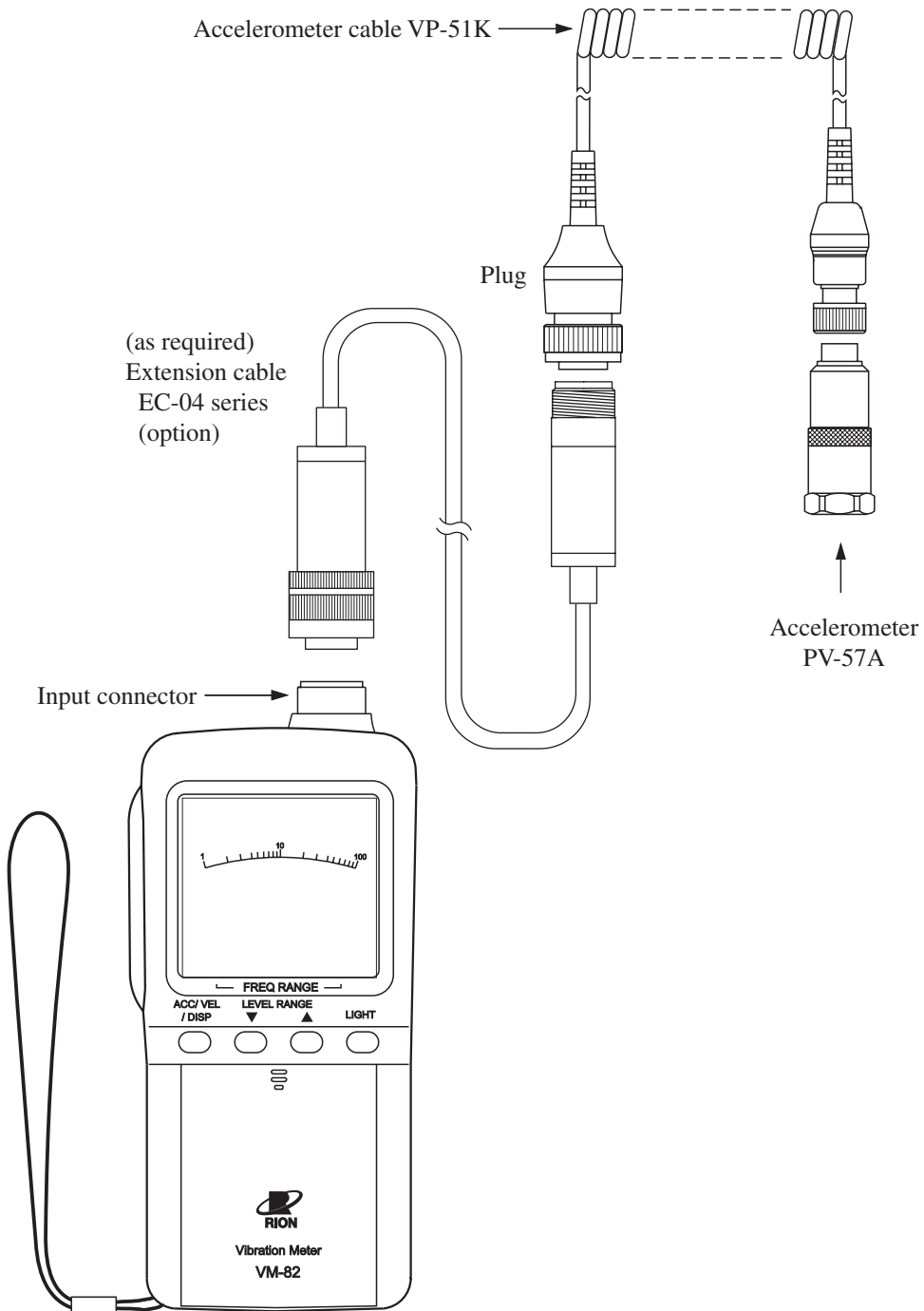

**Important**

Be sure to turn power to the unit OFF before connecting or disconnecting the cable and accelerometer.

**When using a accelerometer without built-in preamplifier**

Make the connection with the optional accelerometer cable VP-51A and preamplifier VP-26C, as shown in the illustration below.

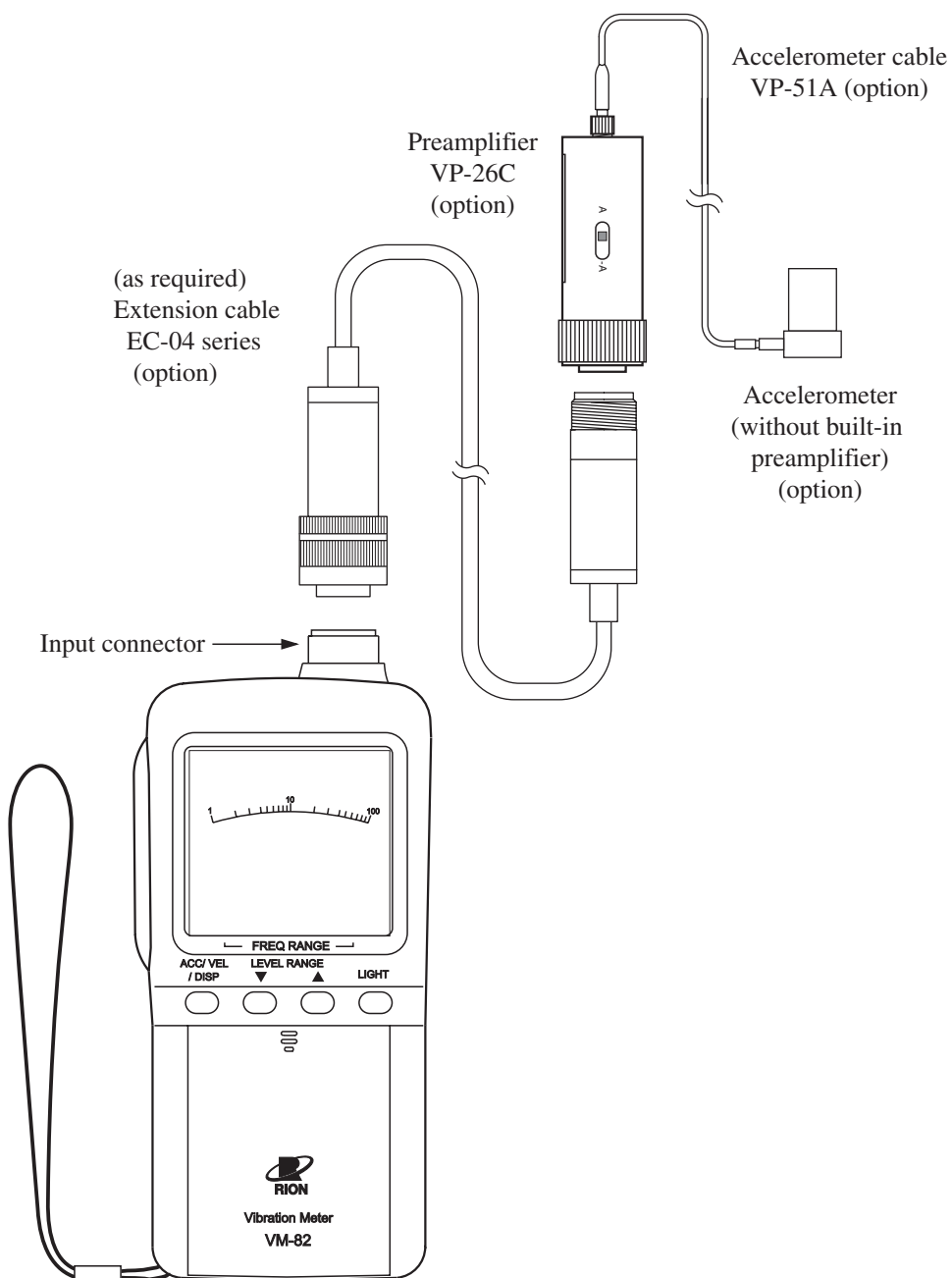

## Accelerometer mounting

There are four basic ways of attaching the accelerometer to the measurement object. The accelerometer mounting method greatly affects the contact resonance frequency\*. The advantages and disadvantages of the four methods are outlined below, to assist you in choosing the proper method.

### \*Contact resonance frequency

When the contact area between the accelerometer and the measurement object is partially deformed, a kind of spring system is created which vibrates at a frequency that is determined by the mass of the spring and the accelerometer. This phenomenon is called contact resonance. The contact resonance varies considerably, depending on the accelerometer mounting method. This affects the upper frequency limit of vibrations that can be measured.

The diagram below shows the change in high-frequency characteristics according on the mounting method. To eliminate the effect of contact resonance as much as possible, the mounting method should be chosen so that measurements in the desired frequency range are possible.

Example for high-frequency characteristics according to mounting method

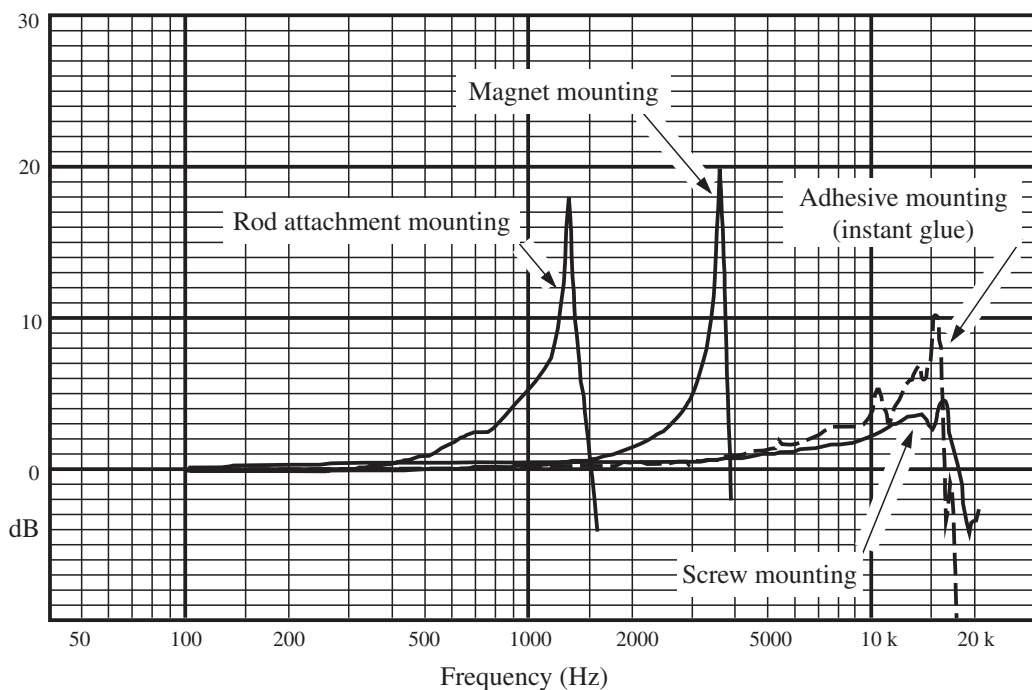

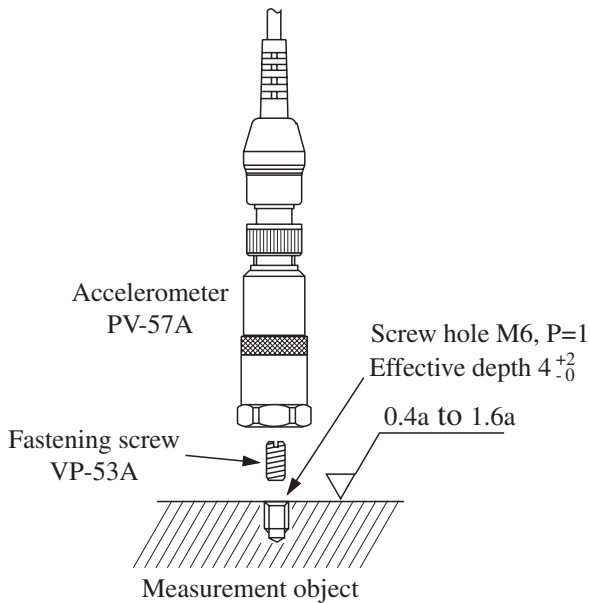

- Screw mounting

This method yields the best vibration characteristics. The mounting surface must have a surface smoothness of 0.4a to 1.6a. Use a fastening torque of 1 to 1.5 N·m for the accelerometer and the screw that joins the accelerometer to the measurement object.

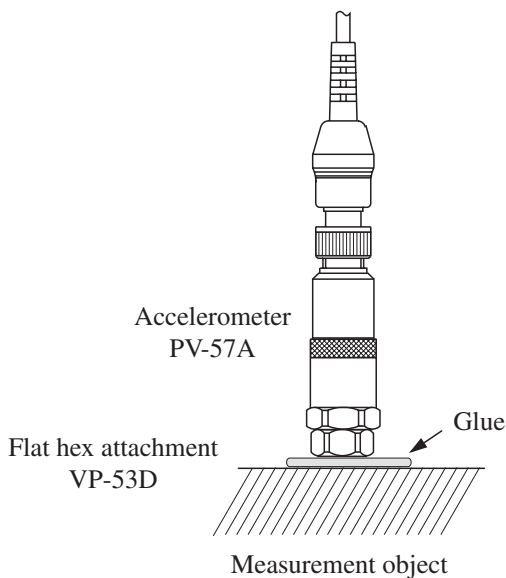

- Adhesive mounting

After screw mounting, this method yields the next best vibration characteristics. Instant glue, epoxy type glue, or a similar adhesive material can be used. Take the surface material of the measurement object into consideration when choosing the glue. (For details, refer to the instructions of the glue.) Before attaching the flat hex attachment for the accelerometer, make sure that the surface of the measurement object is completely clean and free from grease. Use a fastening torque of 1 to 1.5 N·m to join the accelerometer to the flat hex attachment.

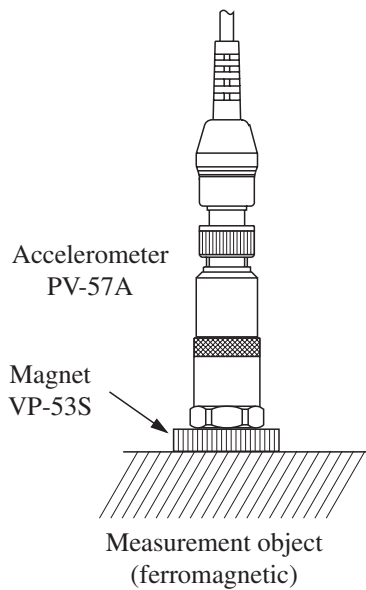

- Magnet mounting  
Because the contact resonance frequency will be quite low, this principle is mainly suited for vibration measurements in the medium to low frequency range. Use a fastening torque of 1 to 1.5 N·m to join the accelerometer to the magnet.

**⚠ Caution**

The magnet is extremely powerful (0.8 to 1 kG). Exercise care when attaching it to the measurement object, to prevent injuries. Keep the magnet at least 50 cm away from objects such as magnetic cards or other magnetic media, to prevent data loss.



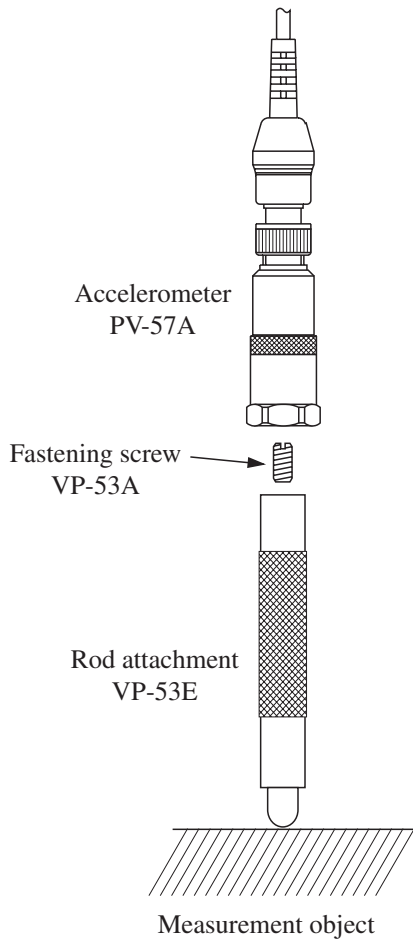

- Rod attachment mounting  
Pressing the accelerometer against the measurement object with a rod is the simplest method, but it is only suitable for measurements below 500 Hz, because contact resonance frequency will be very low. This method should only be used if the shape or material of the measurement object precludes the use of the other three mounting methods. Use a fastening torque of 1 to 1.5 N·m to join the accelerometer to the rod attachment. The rod attachment is made of aluminum alloy (A5052). Lightly grease the screw thread to prevent screw lockup.

## Power-up and version indication/unit initialization

When the power switch on the left side panel of the unit is set to ON, the unit is turned on and the measurement screen that was active before power was last turned off will appear again.

However, if HOLD or RECALL were active, or if the unit was turned off in the setting mode, the immediately preceding condition will be re-established.

### Version indication

If the unit is turned on while holding down the measurement/setting mode selector (MEAS/MODE) on the front panel, the unit version will be shown on the display.

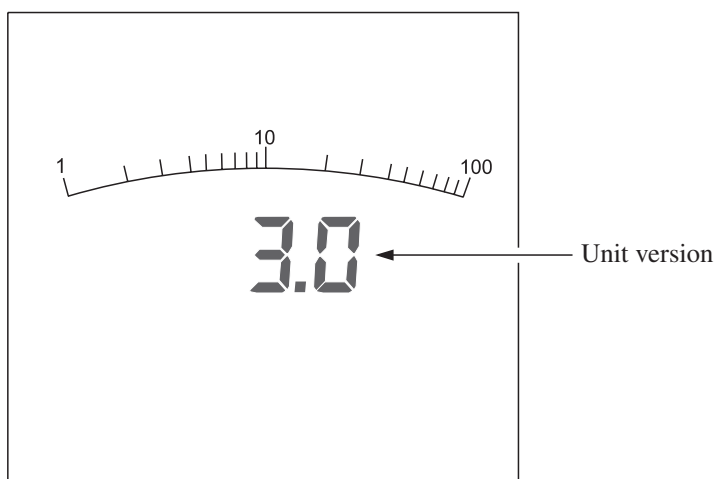

Version indication

Pressing any button in this condition brings up the measurement screen.

Note
This function is only available with unit versions 3.0 and later.

## Initialization

If the unit is turned on while holding down the frequency range selector (FREQ RANGE) on the front panel, the unit will start up in the factory default condition, as shown below.

Accelerometer sensitivity:	5.1 (for supplied PV-57A)
Measurement mode:	m/s <sup>2</sup> (ACC)
Measurement range:	1000 m/s <sup>2</sup>
Display characteristics:	EQPEAK
Frequency range:	HPF 3 Hz, LPF 1 kHz
Store data address:	000

Note
This function is only available with unit versions 3.0 and later.

# Setup

## Setting mode

Each push of the MEAS/MODE button toggles between the measurement mode (MEAS) and setting mode (MODE).

## Setting the date/time and sensitivity

In the setting mode, the setting item selector [▶] moves the current setting item in the order Year → Month → Day → Hour → Minute → Accelerometer sensitivity → Year etc. The time is set and displayed in 24-hour notation.

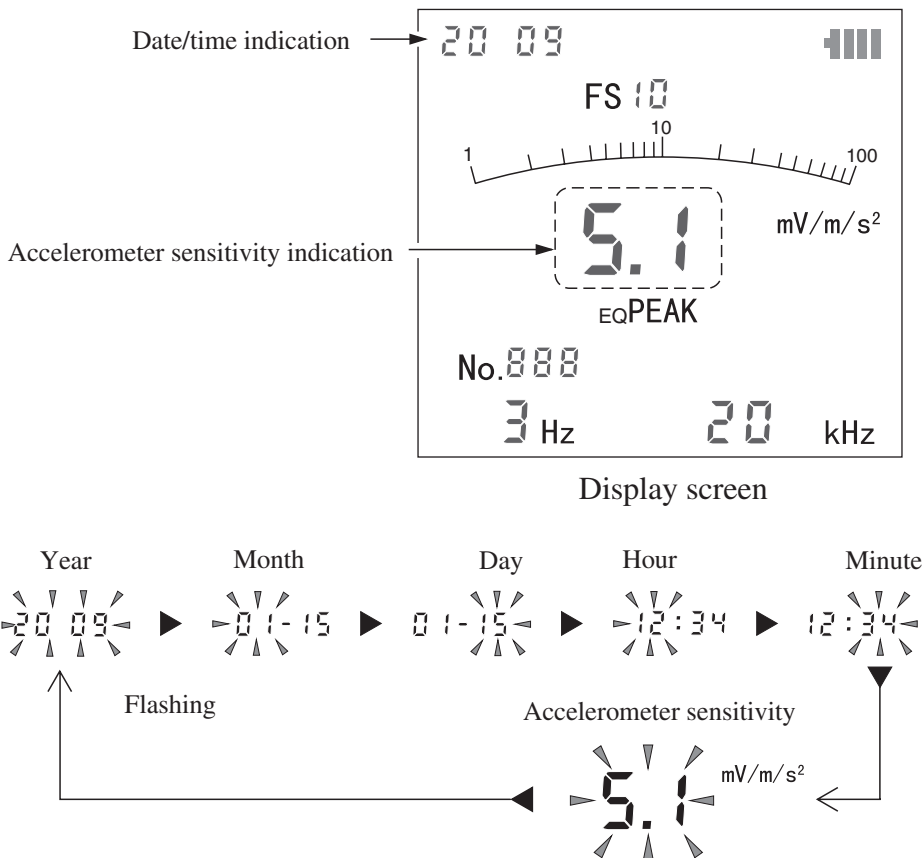

The currently flashing item can be changed. Use the numerical setting buttons [▲] [▼] to change the value. Pressing the [▲] key increases the value and pressing the [▼] key decreases it. Keeping a key depressed for 2 seconds or more causes the value to change rapidly.

## Setting the accelerometer sensitivity

The sensitivity of the supplied accelerometer PV-57A is 5.1 mV/m/s<sup>2</sup>. When using a different accelerometer, change the setting at the VM-82 so that it matches the sensitivity of the accelerometer. (The sensitivity is indicated in the calibration chart that comes with the accelerometer.)

1. Cause the accelerometer sensitivity item to flash (see previous page).
2. Use the numerical setting buttons [▲] [▼] to change the value. Pressing the [▲] key increases the value and pressing the [▼] key decreases it. Keeping a key depressed for 2 seconds or more causes the value to change rapidly. The display range is 0.10 to 99, with the resolution as indicated below.

Display resolution	0.10 to 1.0	“0.01” steps
	1.0 to 10	“0.1” steps
	10 to 99	“1” steps

圧電式加速度ピックアップ校正表 Calibration Certificate	
型式 Model	PV- 85
製造番号 Serial no.	XXXXX
電荷感度 (80Hz) Charge sensitivity	5.90 pC/ms <sup>-2</sup>
ピックアップ静電容量 Capacitance	705 pF
横感度比 (30Hz) Transverse sensitivity	1 %
測定温度 Temperature	21 °C
測定年月 Date	97.01
測定者 Measured by	蓮見
検査責任者 Inspected by	河野
<b>リオン株式会社</b> RION CO., LTD.	

← Charge sensitivity

When using the preamplifier VP-26C, set the charge sensitivity. In the example shown here, the required setting is “5.9”. This means that the preamplifier converts 1 pC of electrical charge into 1 mV.

$$5.9 \text{ pC} / (\text{m} / \text{s}^2) \times \underbrace{1 \text{ mV} / \text{pC}}_{\text{VP-26C}} = \underbrace{5.9 \text{ mV} / (\text{m} / \text{s}^2)}_{\text{Value entered in VM-82}}$$

# Measurement

## Vibration measurement

The following assumes that the preparations described on pages 14 to 23 are completed.

1. Set the power switch of the VM-82 to ON.
2. Select the measurement mode with the measurement mode selector.  
The default settings are shown below. If changes are required, please refer to the section “Setup” on page 26 to 27.

Measurement mode		Frequency range	Display characteristics
ACC (acceleration)	m/s <sup>2</sup>	3 Hz to 1 kHz	EQ PEAK
VEL (velocity)	mm/s	10 Hz to 1 kHz	RMS
DISP (displacement)	mm	10 Hz to 500 Hz	EQ PEAK

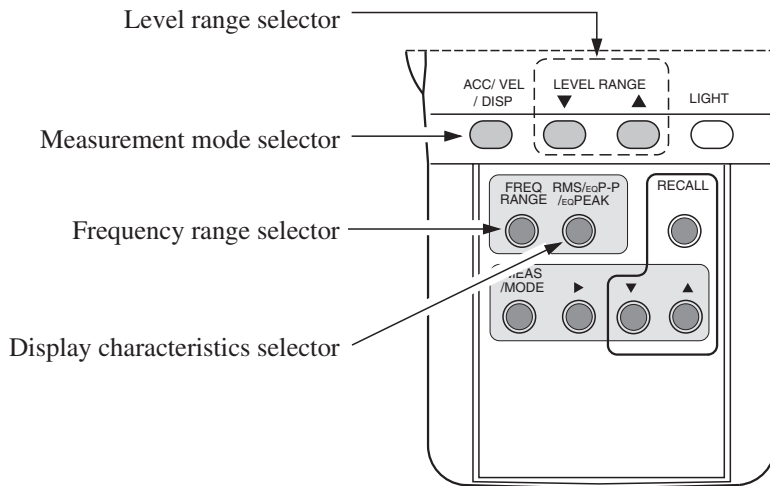

3. Open the setting panel cover and set the frequency range and display characteristics. The relationship between measurement and accelerometer sensitivity, level range, and frequency range is as shown in the table below.

In the ACC mode, when the supplied accelerometer PV-57A is used, sensitivity is  $5.1 \text{ mV}/(\text{m}/\text{s}^2)$ , therefore the measurement full-scale point can be set to a value between 1 and 1000. Set the frequency range to a setting which suits the measurement purpose.

Measurement mode	Accelerometer sensitivity	Measurement range	Frequency range
ACC ( $\text{m}/\text{s}^2$ )	0.1 to 0.99	10 to 10000	3 Hz to 1 kHz
	1.0 to 9.9	1 to 1000	3 Hz to 5 kHz
	10 to 99	0.1 to 100	3 Hz to 20 kHz 1 Hz to 100 Hz
VEL ( $\text{mm}/\text{s}$ )	0.1 to 0.99	100 to 10000	3 Hz to 1 kHz
	1.0 to 9.9	10 to 1000	10 Hz to 1 kHz
	10 to 99	1 to 100	
DISP (mm)	0.1 to 0.99	1 to 1000	3 Hz to 500 Hz
	1.0 to 9.9	0.1 to 100	10 Hz to 500 Hz
	10 to 99	0.01 to 10	

The measurement range can be further increased by using a different accelerometer.

#### Example

When an accelerometer is used which has ten times the sensitivity of the supplied accelerometer PV-57A ( $5.1 \text{ mV}/(\text{m}/\text{s}^2)$ ), the measurement range in ACC mode is 0.1 to 100.

When an accelerometer is used which has 1/10 the sensitivity of the PV-57A, changing the sensitivity setting from  $5.1 \text{ mV}/(\text{m}/\text{s}^2)$  to  $0.51 \text{ mV}/(\text{m}/\text{s}^2)$  yields a measurement range of 10 to 10000.

4. If the input signal overloads the circuitry of the VM-82, the indication OVER appears on the display. Adjust the level range with the level range selector so that OVER does not appear and the measurement value is easy to read.

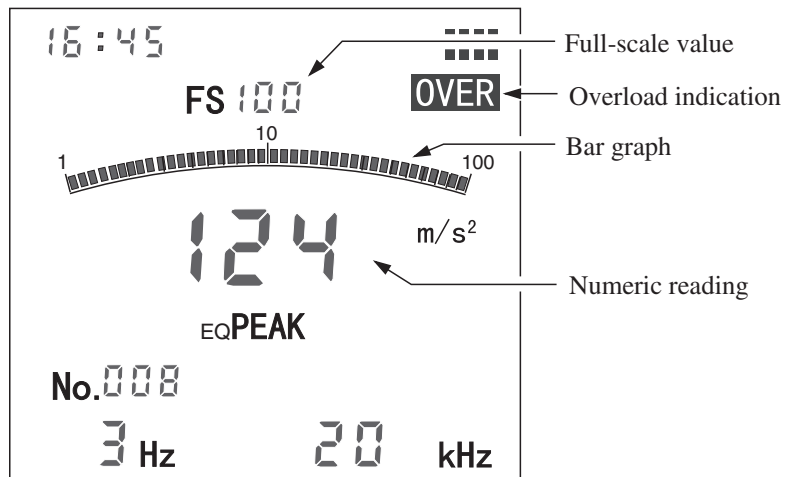

Example for overload (OVER) indication



## Storing measurement data

Displayed measurement data can be stored in the internal memory. The entire display contents except for the bar graph indication and the battery status indication are stored, as listed below.

- Date and time
- Measurement range (full-scale value)
- Measurement value
- Measurement mode
- Display characteristics
- Frequency range
- Overload yes/no

1. When wishing to store the data in a specific address, open the setting panel cover and use the numerical setting buttons to select the address. Then close the cover again.

### Important

When data are stored in an address that already contains data, the previous data will be overwritten.

2. Press the store button to store the currently displayed data. (It is also possible to use the hold button to freeze the display and then perform the store operation.)
3. When the store button is pressed, the display very briefly turns off and the data are stored. The store address is incremented by 1 count. If the store address currently is 999 and the store button is pressed, the next store address will be 000.

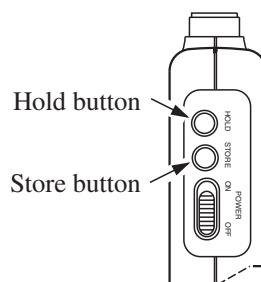

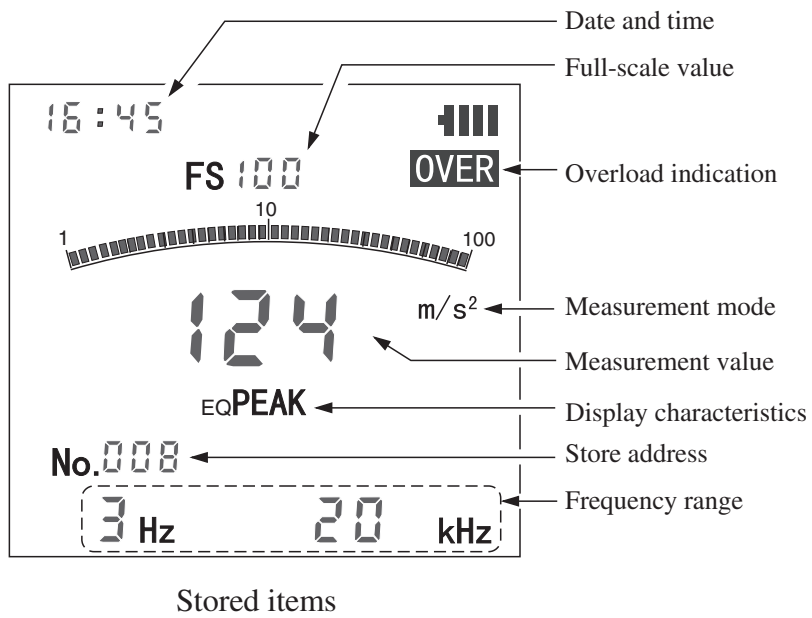

## Recall mode

When the recall button is pressed, the recall mode is activated. The indication **RECALL** appears on the display and stored data are displayed. Pressing the button again switches back to the measurement mode.

1. Open the setting panel cover and press the recall button to activate the recall mode.
2. Use the numerical setting buttons to select the address to be recalled.

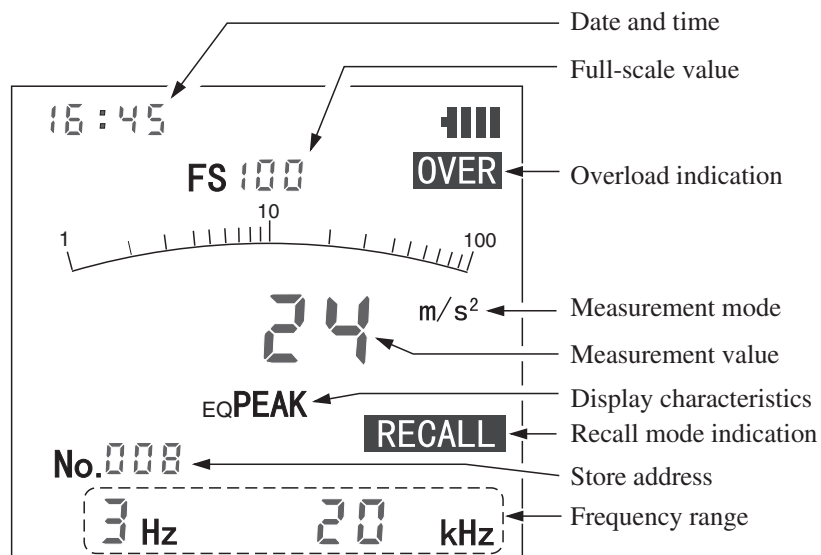
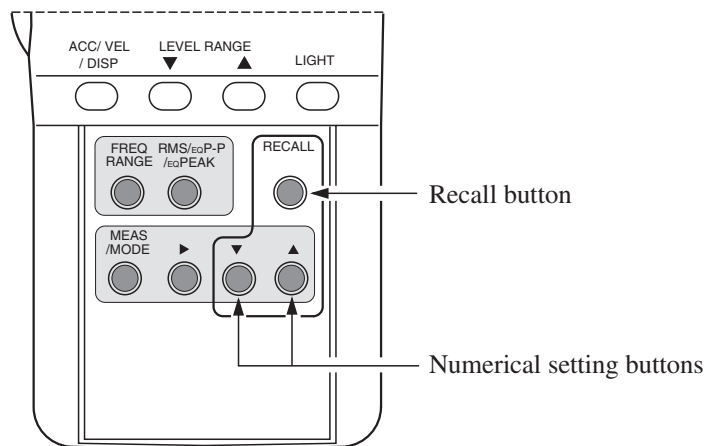

Recall screen example

If there are no stored data in the selected address, the indication becomes as shown below.

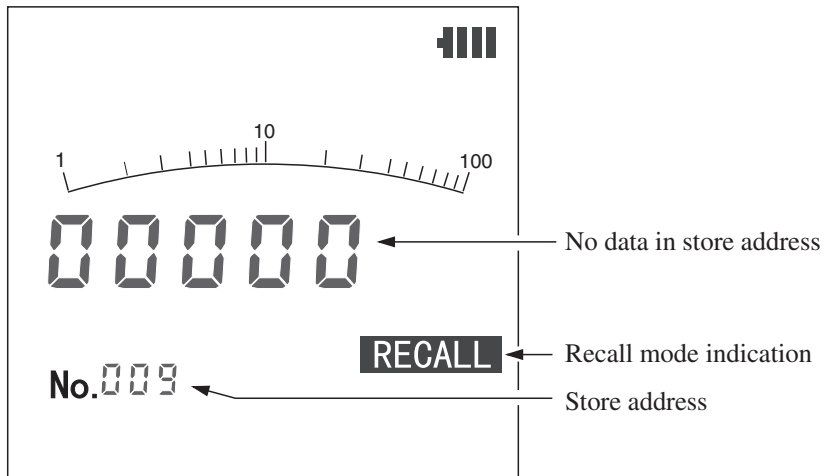

## Clearing stored data

If the unit is turned on while holding down the **RECALL** button on the front panel, all stored data will be cleared. This process will take about five seconds. When it is completed, the measurement screen appears.

Note
This function is only available with unit versions 3.0 and later.

## Output signal recording

On the right side of the unit, there are two outputs that allow monitoring and recording of the signal waveform: OUTPUT AC (AC output) and OUTPUT DC (DC output). Use the optional BNC/phono plug cable CC-24 as shown below to make the connection to a monitor oscilloscope or level recorder.

For a monitor oscilloscope, either the AC output or DC output can be used.

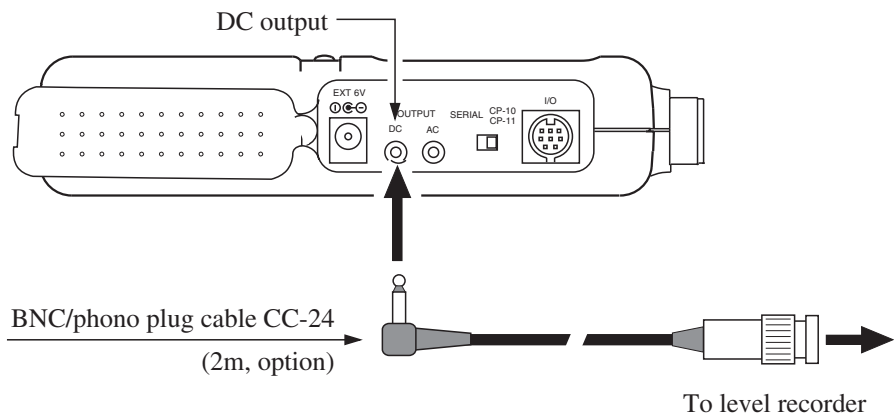
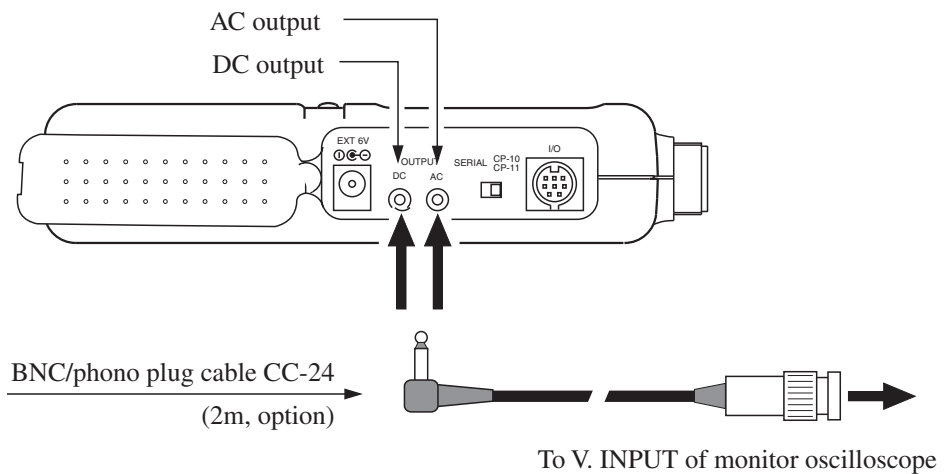

## About the AC OUT signal

The AC output connector on the right side panel of the unit supplies an AC signal corresponding to the selected measurement mode (acceleration/velocity/displacement) and HPF and LPF settings.

The amplitude of the AC signal can be determined from the selected measurement range and voltage value.

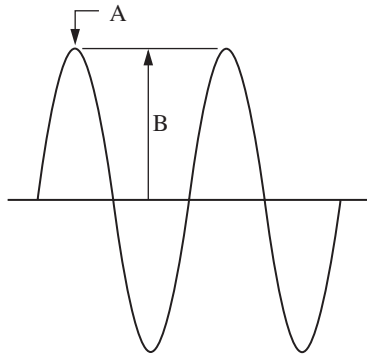

Waveform peak value at point A = B (unit: V) × range full-scale value

Example: Range 10, measurement mode  $\text{m/s}^2$

Range	Voltage B	Peak value
10 $\text{m/s}^2$	10 V	100 $\text{m/s}^2$
10 $\text{m/s}^2$	1 V	10 $\text{m/s}^2$
10 $\text{m/s}^2$	0.5 V	5 $\text{m/s}^2$
10 $\text{m/s}^2$	0.1 V	1 $\text{m/s}^2$

## About the DC OUT signal

The DC output connector on the right side panel of the unit supplies a DC signal that is derived from the AC output signal by rms processing with a time constant of 1 second.

Range full-scale value: 1 V

The measurement value can be determined from the selected measurement range and voltage value, using the graph shown below.

Example: Range 100, measurement mode  $\text{m/s}^2$

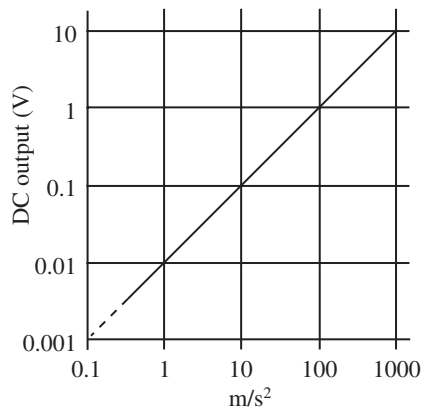

# Serial Interface

The VM-82 incorporates a serial interface that can be used to control the VM-82 with commands sent from a computer and to transfer measurement data from the VM-82 to the computer.

Connect the VM-82 and the computer using a suitable interface cable and set the interface selector of the VM- 82 to SERIAL. This activates the remote mode in which the operation buttons of the VM-82 are inactive.

## Interface parameters

Transfer principle:	asynchronous, half-duplex
Data word length:	8 bit
Stop bits:	2
Parity:	none
Transfer rate:	4800 bps



## Transfer Procedure

### Sending commands

In order to control the VM-82 from a computer or to retrieve measurement data, certain commands must be sent to the VM-82. The data exchange must be performed according to certain rules, to ensure that both the VM-82 and the computer recognize the commands and data properly.

To send commands to the VM-82, the following procedure is used.

1. The computer sends `<ENQ>` to the VM-82.
2. When `<ENQ>` has been received, the VM-82 returns `<ACK>READY<CR><LF>` to the computer.
3. The computer verifies receipt of `<ACK>READY<CR><LF>` and sends a command within 4 seconds.

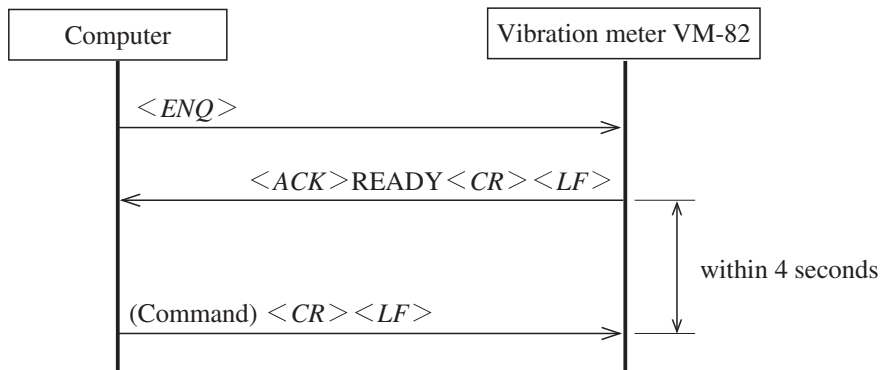

- `<ENQ>`: Control code 05H (enquire)  
`<ACK>`: Control code 06H (acknowledge)  
`<CR>`: Control code 0DH (carriage return)  
`<LF>`: Control code 0AH (line feed)  
 READY: ASCII string  
 (command): ASCII string (command and parameters)

## Sending data

When a command (delimited by `<CR><LF>`) is received by the VM-82, it interprets the command and executes it. If it is a command which requests data, the appropriate data are sent to the computer. When there is a large amount of data, they are divided into blocks and only the first block is sent. The VM-82 then waits for an `<ACK>` from the computer before sending the next block. The computer must send the `<ACK>` within 4 seconds to continue to receive data.

Data can be sent in one block

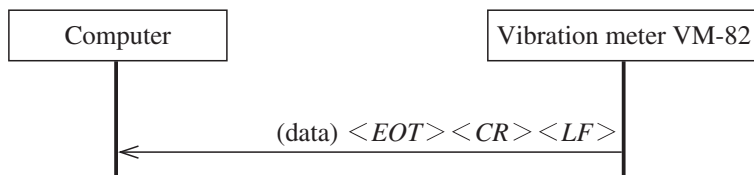

Data must be divided into several blocks (example: 3 blocks)

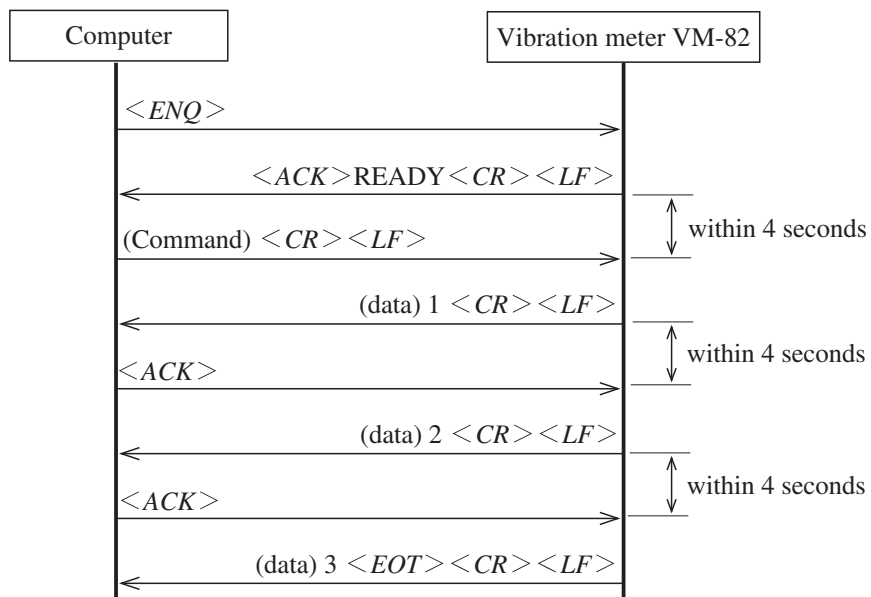

`<EOT>`: Control code 04H (end of transfer)

`(data)`: ASCII string (data requested by command)

When there are no more data,  $\langle EOT \rangle$  is appended to the end of the last data. The computer must check for  $\langle EOT \rangle$  to determine whether to terminate the transfer or send  $\langle ACK \rangle$  for receiving further data.

Data are divided into blocks only when data stored in memory are retrieved.

## Error Processing

In order to ensure correct data exchange between the VM-82 and the computer, the rules described above must be observed. If an error occurs, the following steps should be taken.

- The computer has sent `<ENQ>` but no response is received from the VM-82.
  - Send `<ENQ>` again after about 2 seconds. Repeat this 5 to 6 times.
  - If there is still no response from the VM-82, one of the following conditions may exist:
    - Communication parameters do not match.
    - Interface cable is defective or not properly connected.
    - VM-82 is not powered.
- `<ACK>READY<CR><LF>` from the VM-82 was received, but the computer has not completed the sending of commands within 4 seconds.
  - The VM-82 terminates the data transfer condition. Send `<ENQ>` from the computer again.
- The computer has not sent `<ACK>` within 4 seconds to receive further data.
  - The VM-82 abandons the data transfer and does not send the remaining data.
- A wrong command was sent.
  - When the computer has sent a wrong command (invalid string or parameter out of range), the VM-82 disregards the command.

## Command format

Commands that can be used by the VM-82 consist of 3 characters (3 bytes), usually followed by a parameter. The parameter specifies the action of the command.

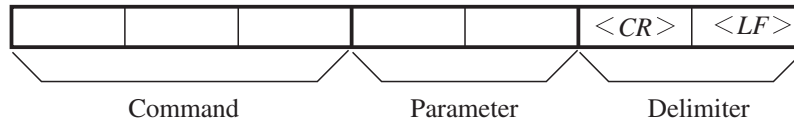

There are two types of parameters:

- Parameters which make a setting for the function specified by the command
- Parameters which request setting information for the function specified by the command

The first type of parameter can be from 1 to 7 characters (1 to 7 bytes). The second type of parameter is a "?". In the following command description, the first type of parameter is denoted by "n". Data returned by the VM-82 in response to the information request parameter are denoted by "p".

Note
The VM-82 cannot process multiple commands sent together.

## Command list

Command	Function	Page
BAT?	Get battery status .....	45
DETh	Set display characteristics .....	45
DOD?	Get measurement data .....	45
DOF	Output instantaneous data .....	46
DOR?	Get data stored in memory .....	47
FLTh	Set frequency range.....	47
MCL	Clear data memory .....	47
RNGn	Set range .....	48
SNSn	Set sensitivity .....	48
STS?	Get function settings .....	49
UNTh	Set measurement mode.....	49

## Command description

### BAT? Get battery status

Data output by vibration meter in response to BAT?: p

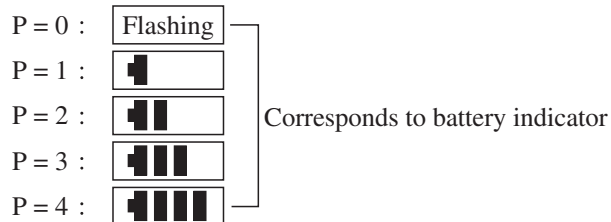

### DEtn Set display characteristics (ID.MODE)

- n = 0: RMS
- n = 1: EQ PEAK
- n = 2: EQ P-P

For ACC, and VEL, n = 2 is disregarded

### DOD? Get measurement data

Output data format

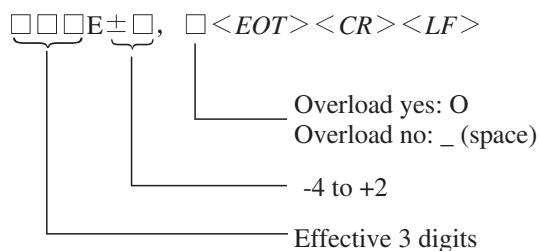





**DOR? Get data stored in memory**

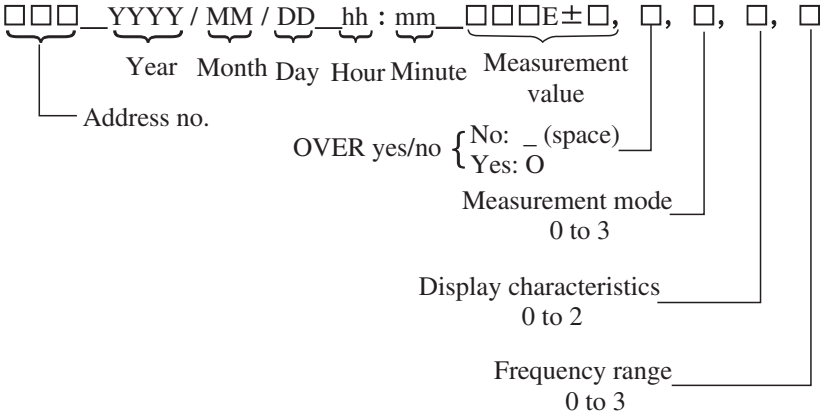

**FLTn Set frequency range**

	n = 0	n = 1	n = 2	n = 3
ACC	3 Hz to 1 kHz	3 Hz to 5 kHz	1 Hz to 100 Hz	3 Hz to 20 kHz
VEL	10 Hz to 1 kHz	3 Hz to 1 kHz	—	—
DISP	10 Hz to 500 Hz	3 Hz to 500 Hz	—	—

For VEL and DISP, n=2 and n=3 are disregarded.

**MCL Clear data memory**

Set address to 000.

## RNGn Set range

Sensitivity	Measurement mode	n = 0	n = 1	n = 2	n = 3
0.10 to 0.99	DISP	1	10	100	1000
	ACC	10	100	1000	10000
	VEL	100	1000	10000	—
1.0 to 9.9	DISP	0.1	1	10	100
	ACC	1	10	100	1000
	VEL	10	100	1000	—
10 to 99	DISP	0.01	0.1	1	10
	ACC	0.1	1	10	100
	VEL	1	10	100	—

For VEL, n=3 is regarded as equal to n=2.

## SNSn Set sensitivity

n = 1000 to 9900: 10 to 99

n = 0100 to 0990: 1.0 to 9.9

n = 0010 to 0099: 0.10 to 0.99

# STS? Get function settings

Output format

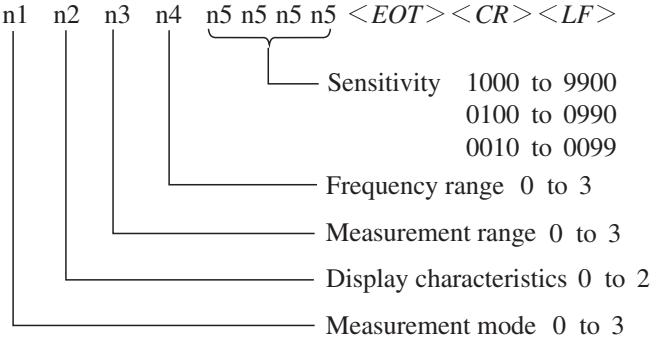

# UNtn Set measurement mode

- n = 1: ACC (m/s<sup>2</sup>)
- n = 2: VEL (mm/s)
- n = 3: DISP (mm)

# Reference

## High-pass filter characteristics

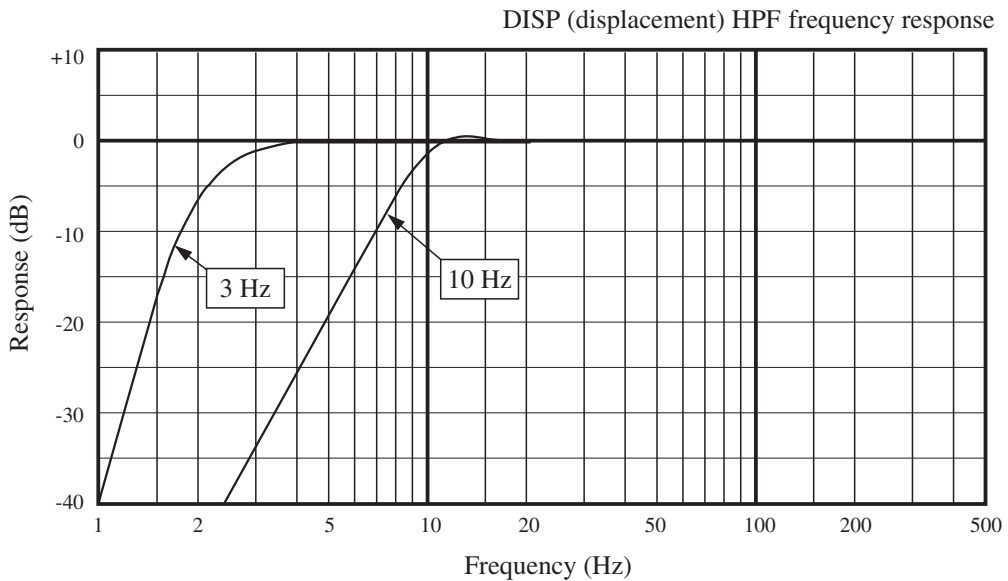
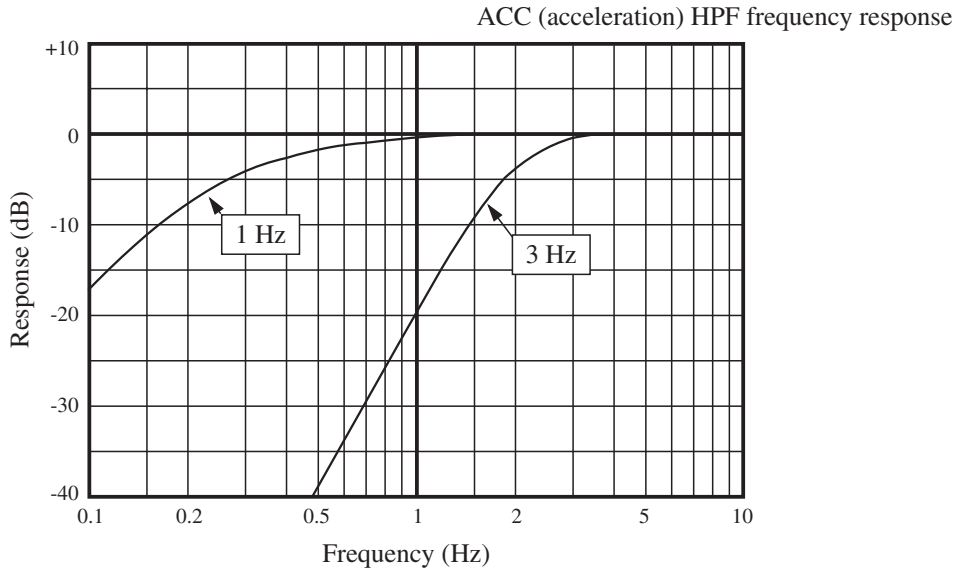

## Low-pass filter characteristics

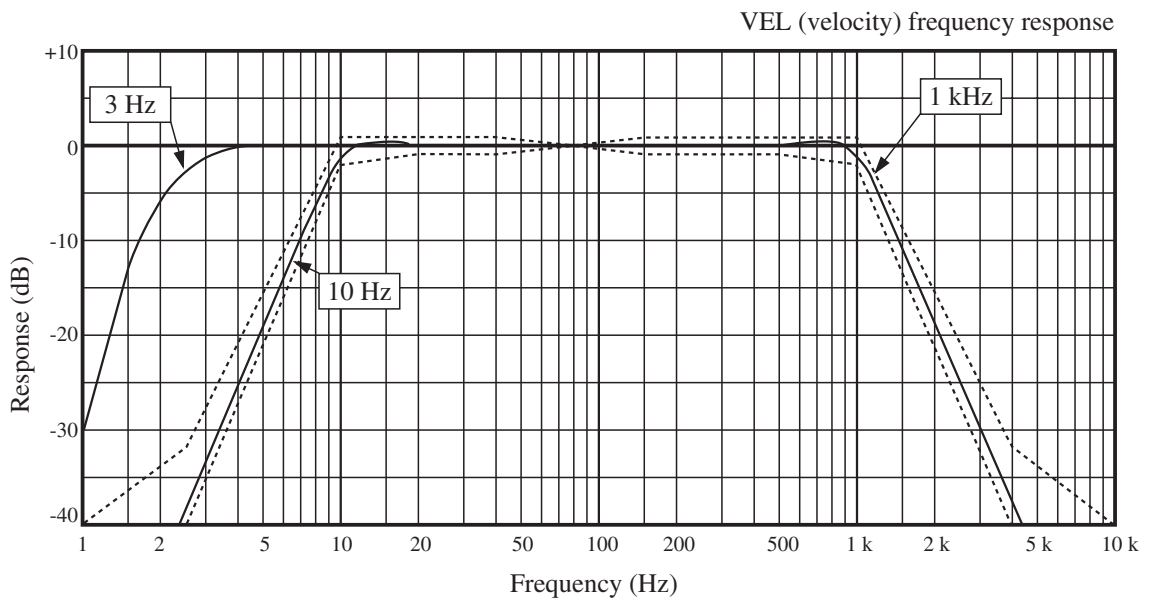
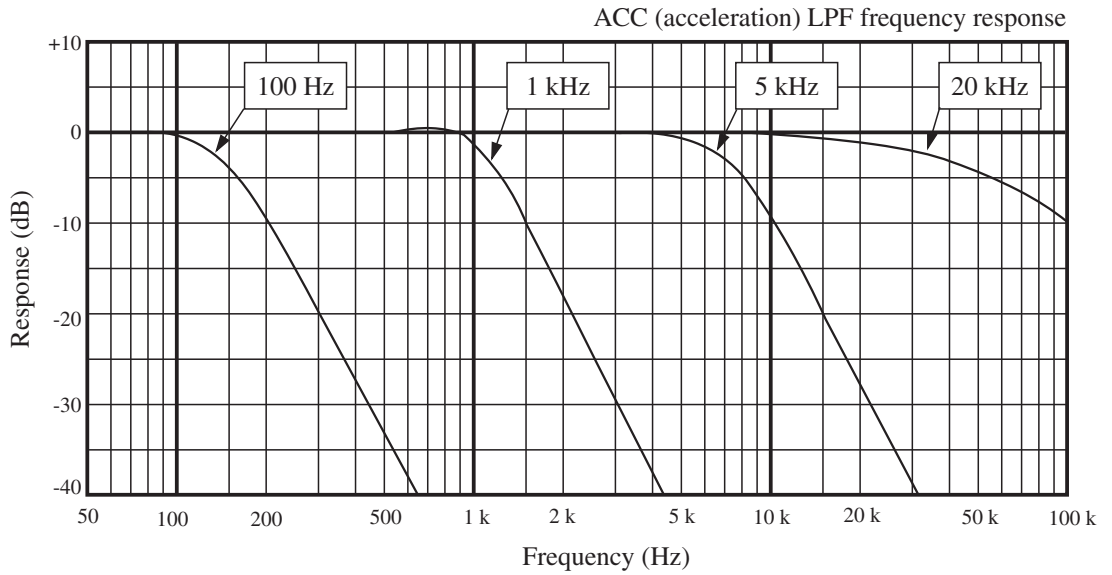

Dotted lines indicate the allowable range according to JIS B 0907:1989

## Input connector wiring diagram

The input connector pinout is shown below.

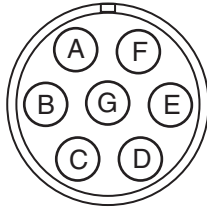

- A: +12 V
- B: Ground
- C: Signal input
- D: -12 V
- E: NC
- F: NC
- G: NC

NC: Not connected  
(Do not use these pins.)

# Use of Optional Accessories

## Use of AC adapter (option)

To power the unit from the optional AC adapter NC-34 or NC-98 series, establish connections as shown below.

NC-34: For 100 V AC only      NC-98 series: For 100 to 240 V AC

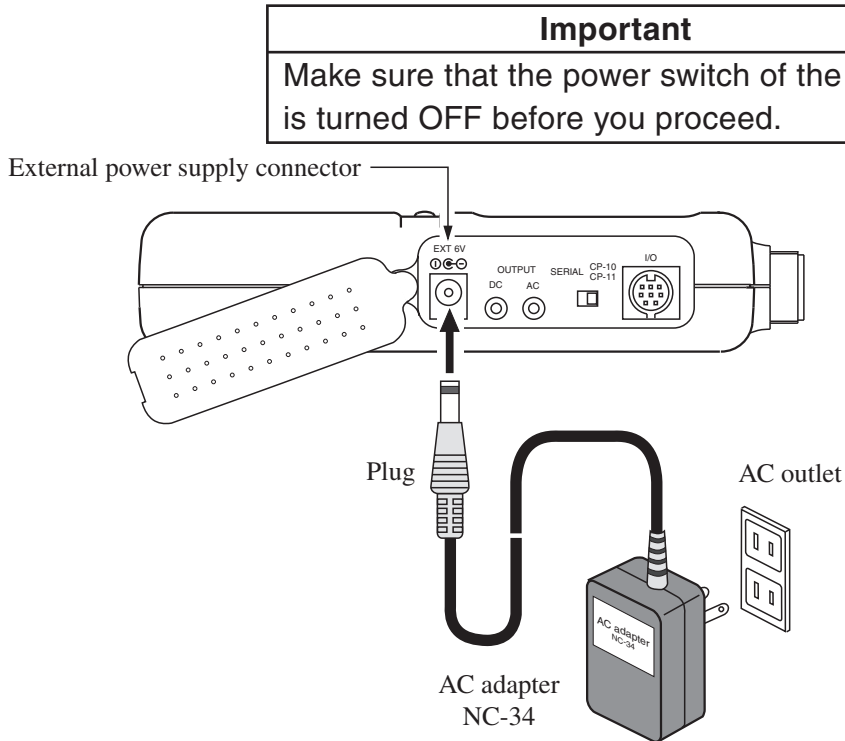

### **⚠ Caution**

Use only the specified AC adapter. Using a different adapter may cause malfunction or damage.

During use of the AC adapter, do not coil up the cable. Do not cover the AC adapter or cable with paper, cloth or any other object, to prevent danger caused by overheating.

After use, always disconnect the AC adapter from the AC outlet.

## Connection to a printer

For using the printer with the VM-82, use the optional connection cable CC-87 and make the connection as shown below.

The printer models DPU-414 (Seiko Instruments), CP-10, and CP-11 can be connected.

**Important**

Make sure that the power switches of the VM-82 and the printer are turned OFF before you proceed.

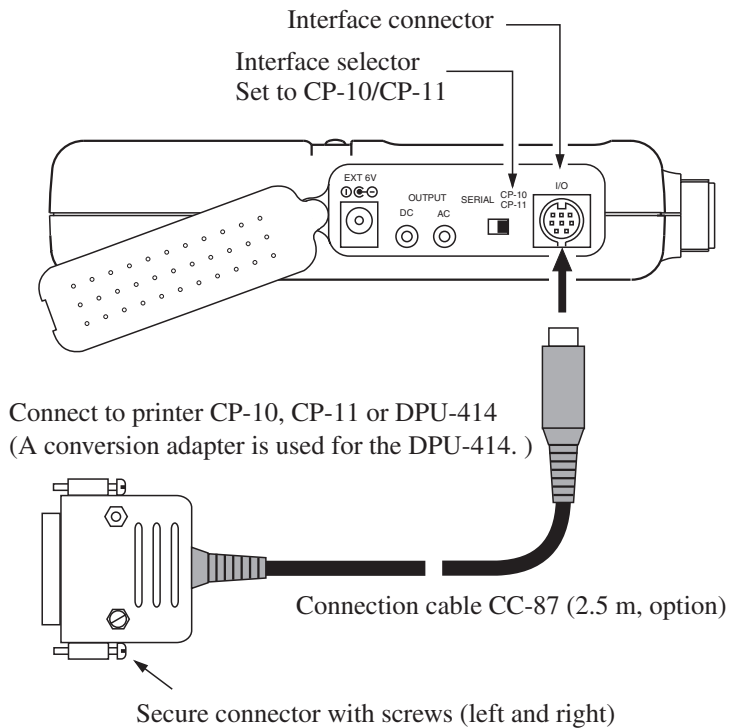



## Printing

1. Set the power switch of the VM-82 to OFF.
2. Verify that the interface selector of the VM-82 is set to CP-10/CP-11 (see previous page).
3. Set the DIP switches of the printer CP-10 or CP-11 as follows.

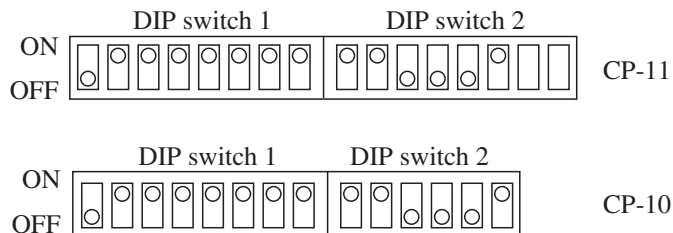

4. Set the printer power switch to ON.
5. Press the on-line/off-line button of the printer so that the on-line indicator is lit.
6. Set the power switch of the VM-82 to ON. Printing is activated at this point and will continue for as long as the VM-82 is turned on.

When printing is not required, disconnect the connection cable.

For information on setting of the printer DPU-414 (Seiko Instruments), please refer to the instruction manual supplied with the printer.

## Printout example

An example for printout using the printer CP-11 is shown below.

Data are printed out while performing the measurement. Printed values are average value for sample data with 2-second interval. An asterisk (\*) appended to a value lower than the full-scale value means that overload (OVER) has occurred during the 2-second averaging interval.

1997 01/15 12:34 *OVER				
DISP	mm	EQ	PEAK	FS 0.1
FREQ	RANGE	3Hz	~	500Hz
0.003	0.124*	0.114*	0.049	0.018
0.007	0.003	0.022	0.057	0.037
0.018	0.014	0.089*	0.116*	0.051
0.029	0.021	0.008	0.008	0.021
0.013	0.018	0.024	0.021	0.017
0.017	0.015	0.020	0.041	0.017
1997 01/15 12:35				
0.017	0.024	0.023	0.015	0.025
0.111*	0.099*	0.038	0.019	0.017
0.028	0.023	0.019	0.031	0.026
0.050*	0.127*	0.109*	0.082*	0.127*
0.095*	0.037	0.014	0.006	0.010
0.014	0.011	0.010	0.009	0.009
1997 01/15 12:36				
0.011	0.010	0.010	0.010	0.014

An example for printout of recalled data is shown below.

No. 000	1997	01/16	11:55		
	4.2 m/ss	EQ PEAK	FS	10	
	FREQ RANGE	3Hz ~		1kHz	
No. 001	1997	01/16	11:55		
	2.6 m/ss	EQ PEAK	FS	10	
	FREQ RANGE	3Hz ~		1kHz	
No. 002	1997	01/16	11:56		
	1.08 m/ss	RMS	FS	1	
	FREQ RANGE	1Hz ~		100Hz	
No. 003	1997	01/16	11:56		
	0.43 m/ss	RMS	FS	1	
	FREQ RANGE	1Hz ~		100Hz	
No. 004	1997	01/16	11:56		
	38 mm/s	RMS	FS	100	
	FREQ RANGE	10Hz ~		1kHz	
No. 005	1997	01/16	11:57		
	70 mm/s	RMS	FS	1000	
	FREQ RANGE	10Hz ~		1kHz	
No. 006	1997	01/16	11:58		
	0.4 mm	EQ PEAK	FS	10	
	FREQ RANGE	3Hz ~		500Hz	

Stored data ranging from the address number selected when the recall button was pressed to address number 999 are printed out.

For printing recalled data, establish connections by completing the procedures on page 55 and press the recall button.

## Connection to a computer

When connecting the VM-82 to a computer, use the optional connection cable CC-87E and make the connection as shown below.

<b>Important</b>
Make sure that the power switches of the VM-82 and the computer are turned OFF before you proceed.

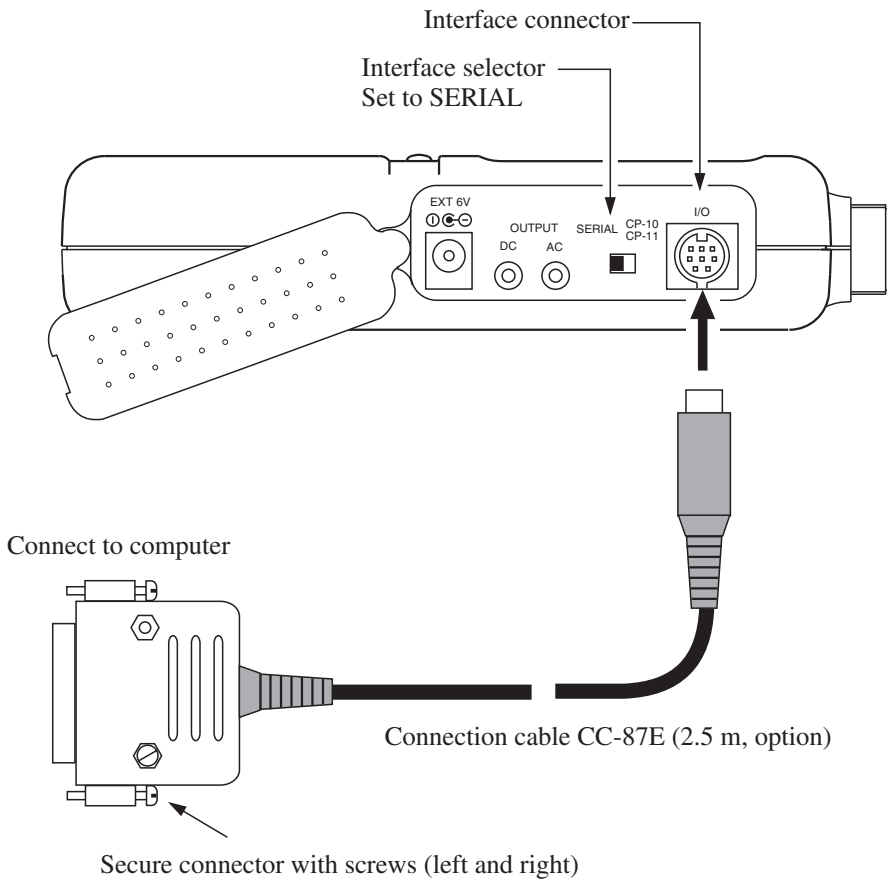

# Specifications

## Accelerometer PV-57A (standard accessory)

### Accelerometer type

Shear-type piezoelectric accelerometer (with integrated preamplifier)

Sensitivity 5.1 mV/(m/s<sup>2</sup>) ±3% 80 Hz, 23°C

Frequency range 1 Hz to 5 kHz (±10%)

Dimensions 17 mm (width across hexagonal flat) × 49 mm

Weight Approx. 45 g

### Other usable accelerometer types

PV-55 (direct connection possible)

Accelerometers with integrated preamplifier rated for 2 mA drive current can be connected via adapter UA-07 or UA-08.

Accelerometers without integrated preamplifier can be connected via preamplifier VP-26C.

Depending on the choice of accelerometer, very low vibration levels or high acceleration values can be measured.

## Measurement range (with PV-57A)

### Acceleration (ACC)

0.02 to 200 m/s<sup>2</sup> EQ PEAK 1 Hz to 5 kHz

Velocity (VEL) 0.3 to 1000 mm/s RMS 3 Hz to 1 kHz

0.1 to 1000 mm/s RMS 10 Hz to 1 kHz

### Displacement (DISP)

0.02 to 100 mm EQ PEAK 3 Hz to 500 Hz

0.001 to 100 mm EQ PEAK 10 Hz to 500 Hz

Upper and lower measurement limit may be further restricted, depending on accelerometer mounting method.

Upper measurement limit for velocity and displacement measurements is restricted by maximum input acceleration.

## Frequency range

## Acceleration (ACC)

3 Hz to 1 kHz, 3 Hz to 5 kHz, 1 Hz to 100 Hz, 3 Hz to 20 kHz

Velocity (VEL) 10 Hz to 1 kHz, 3 Hz to 1 kHz

## Displacement (DISP)

10 Hz to 500 Hz, 3 Hz to 500 Hz

The above figures refer to the point where response is down by 10% from flat response, due to the action of a high-pass filter or low-pass filter. For displacement measurements, the 500 Hz limit is imposed by the maximum input acceleration. The electrical characteristics of 10 Hz to 1 kHz for velocity correspond to JIS B 0907:1989 (Requirements for Instruments to Measure Vibration Severity in Rotational and Reciprocal Machinery).

## Measurement range settings

For accelerometer PV-57A and

accelerometers with sensitivity 1.0 to 9.9 mV/(m/s<sup>2</sup>) (1.0 to 9.9 pC/(m/s<sup>2</sup>))

Acceleration (ACC m/s<sup>2</sup>)

1, 10, 100, 1000

Velocity (VEL mm/s)

10, 100, 1000

Displacement (DISP mm)

0.1, 1, 10, 100

When accelerometer sensitivity is 0.1 to 0.99 mV/(m/s<sup>2</sup>) (0.1 to 0.99 pC/(m/s<sup>2</sup>)), above ranges are to be multiplied by a factor of 10.

When accelerometer sensitivity is 10 to 99 mV/(m/s<sup>2</sup>) (10 to 99 pC/(m/s<sup>2</sup>)), above ranges are to be multiplied by a factor of 1/10.

## Display characteristics

Acceleration	EQ PEAK, RMS
Velocity	RMS, EQ PEAK
Displacement	EQ PEAK, EQp-p, RMS
	EQ PEAK = RMS $\times \sqrt{2}$
	EQ p-p = EQ PEAK $\times 2$

## LCD panel

Measurement value display range:

001 to 128

Average of 20 100-ms sampling data is displayed, updated every 2 seconds

Bar graph display Logarithmic scale, full-scale 1 to 100%

Display characteristics

RMS, EQ PEAK, EQp-p

Measurement modes

m/s<sup>2</sup>, mm/s, mm

Frequency range Selected range for each measurement mode shown at bottom of display

Memory addresses 000 to 999 (1000 addresses)

Battery status indication

4-segment display

Clock indication Year, month, day, hour, minute

Accelerometer sensitivity

0.10 to 0.99, 1.0 to 9.9, 10 to 99 mV/m/s<sup>2</sup>

Backlight LED type backlight

Data memory Maximum 1000 data (000 to 999) can be stored manually.

Stored data comprise all display contents except battery status.

Long-term retention of data

(With unit versions prior to 3.0, data are preserved by backup battery)

Gain calibration After setting the accelerometer sensitivity, calibration is performed to provide proper gain.

Setting range 0.10 to 0.99, 1.0 to 9.9, 10 to 99 pC/m/s<sup>2</sup> (mV/m/s<sup>2</sup>)

Overload indication	“OVER” shown on LCD panel
Output	
AC output	Range full-scale: 1 V Output impedance: approx. 600 W
DC output	Range full-scale: 1 V Output impedance: approx. 600 W
Output voltage and display accuracy (electrical characteristics)	
Acceleration (ACC)	Range full-scale $\pm 2\%$ (80 Hz)
Velocity (VEL)	Range full-scale $\pm 3\%$ (80 Hz)
Displacement (DISP)	Range full-scale $\pm 5\%$ (80 Hz)
Overall accuracy (in combination with PV-57A)	
Acceleration (ACC)	Range full-scale $\pm 5\%$ (80 Hz)
Interfaces	
Serial interface	For data output and remote control of VM-82
Printer interface	For output of data to printer (CP-10, CP-11, DPU-414)
Ambient conditions	
Accelerometer	-20°C to +70°C, max. 90% RH
Main unit	-10°C to +50°C, max. 90% RH
Power requirements	IEC R6P batteries ( $\times 4$ ) or AC adapter (NC-34 for 100 V AC or NC-98 series for 100 to 240 V AC, optional)
Power consumption	Approx. 55 mA (6 V, backlight off, communication off)
Battery life	(continuous use, on room temperature, backlight off, communication off) Alkaline batteries: approx. 30 hours Manganese batteries: approx. 14 hours
Dimensions	167.5 (H) $\times$ 76 (W) $\times$ 35 (D) mm
Weight	Approx. 320 g (including 4 manganese batteries)



## Supplied accessories

Accelerometer (PV-57A)		1
Accelerometer accessories		
Accelerometer cable	VP-51K	1
Magnet attachment	VP-53S	1
Rod attachment	VP-53E	1
Hex flat attachment	VP-53D	1
M6 screws	VP-53A	2
IEC R6P batteries		4
Soft carrying case		1
Instruction manual		1
Inspection certificate		1

## Optional accessories

Accelerometer	PV-55 and others
Preamplifier	VP-26C
Printer	DPU-414
Calibration exciter	VE-10
AC adapter	NC-98 series, NC-34
Extension cable	EC-04 series
Connection cable (D-sub 9 pin)	CC-87E
Connection cable (D-sub 25 pin)	CC-87
BNC-RCA cable	CC-24

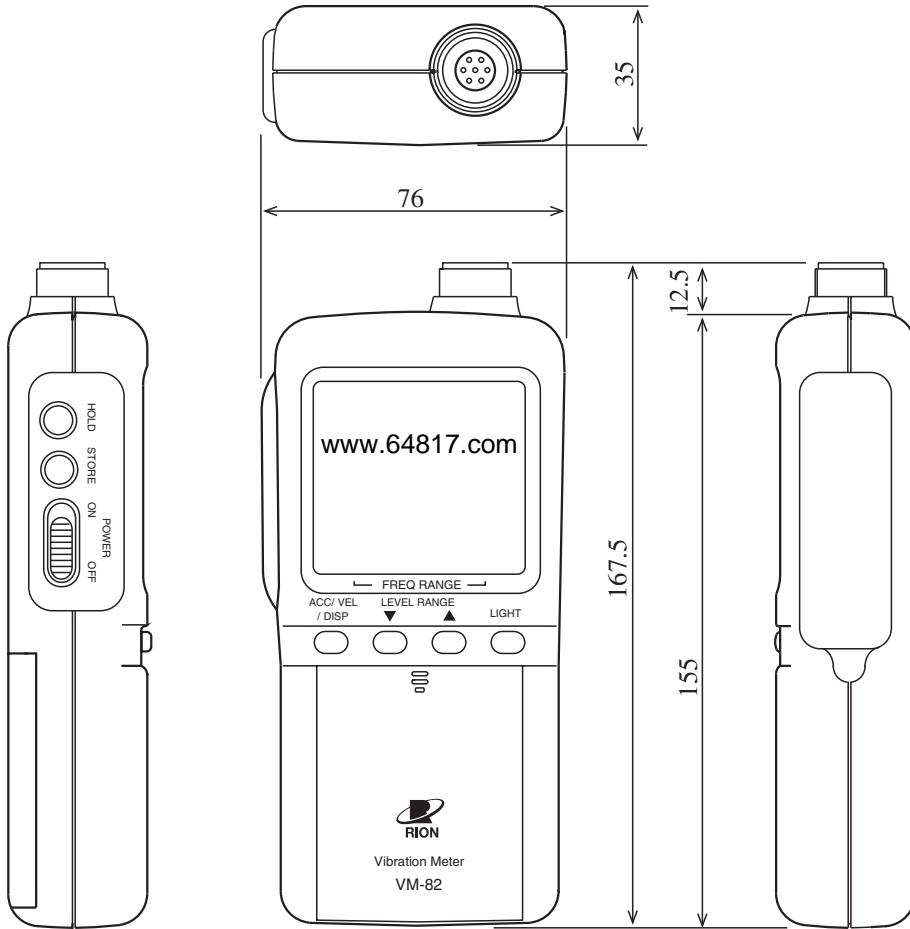

VM-82 External dimensions

Unit: mm

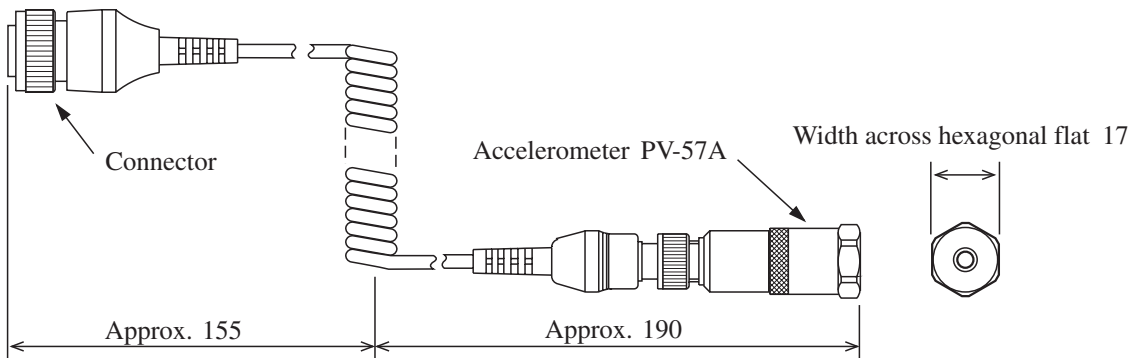

PV-57A External dimensions

Unit: mm



